

XBRL US GAAP Taxonomy Preparers Guide

Notice Authorized Uses of this Document

Copyright © 2008 XBRL US, Inc.

All Rights Reserved

In order to meet the SEC's mission requirements, the US GAAP Financial Statement Taxonomy may be used by the public, royalty-free, in US GAAP reporting, and may be incorporated without change in other works that comment on, explain, or assist in the use or implementation of the US GAAP Financial Statement Taxonomy.

To that end, this document and translations of it may be copied and furnished to others, in whole or in part, and this document may be incorporated, in whole or in part, without change, in other works that comment on or otherwise explain the US GAAP Financial Statement Taxonomy or assist in its implementation. Other works that incorporate this document, in whole or in part, without change, may be prepared, copied, published, and distributed without restriction of any kind, provided this Notice is included on the first page of all such authorized copies and works and the legend set forth below is contained on each subsequent page of such documents. Under no circumstances may this document, or any part of it that is incorporated into another work, be modified in any way, such as by removing the copyright notice or references to XBRL US, Inc., except as required to translate it into languages other than English or with prior written consent of XBRL US, Inc.

XBRL US, Inc. owns all right, title, and interest in the US GAAP Financial Statement Taxonomy and all technical data, software, documentation, manuals, instructional materials, and other information created in connection with the US GAAP Financial Statement Taxonomy—which includes this document. The SEC has an unlimited license in the GAAP Financial Statement Taxonomy and this other information and materials pursuant to Federal Acquisition Regulation ("FAR") 52.227-11, 52.227-14 (Alternative IV) and 52.227-16.

Domain Steering Committee of XBRL US, Inc.

Technical Guidance

Campbell Pryde, Chair
Morgan Stanley

Susan Smoter
Internal Revenue Service

Matthew Slavin
Ernst & Young

John Stantial
United Technologies Corporation

Paul Sappington, Vice Chair
Edgar Online

Sanjay Jacob
Microsoft Corporation

XBRL US Authors and Editors

Brad Homer
XBRL Technical Manager
AICPA

Kristy L. Illuzzi, CPA
Technical Manager
Accounting and Auditing Publications
AICPA

Walter Hamscher
President and CEO
Standard Advantage

Linda Prentice Cohen
Director of Publishing
AICPA

Landon Westerlund
Partner
KPMG LLP

Dave Cohen
Developmental Editor
Accounting and Auditing Publications
AICPA

Notice to Readers

This eXtensible Business Reporting Language ([XBRL](#)) US GAAP Taxonomy Preparers Guide provides preparers of financial statements with a foundation for working with XBRL. This document is designed to explain XBRL terminology and concepts to an extent that will allow preparers to understand how to format financial statements in XBRL. It also provides reviewers of financial statements prepared in XBRL by third parties with knowledge needed to make informed decisions. For preparers, it provides a methodology for approaching XBRL for financial reporting, rules to follow, and rules of thumb for getting the most out of XBRL technology. This guide is not designed to be a step-by-step blueprint for creating XBRL-embedded documents, and it does not contain company- or industry-specific information nor advice regarding XBRL. In addition, this guide does not and cannot, by its very nature, cover everything related to XBRL. Instead, this guide provides a framework of XBRL essentials and information that enables preparers to proceed in an XBRL financial reporting environment.

XBRL is a web-based technology, but this guide is not itself technical and does not require any particular IT skills or knowledge. This guide also does not address any specific software product issues, and it makes no vendor- or product-specific recommendations. The guide discusses the various *types* of software available for performing different XBRL-related functions, but it is not a manual and is not a recommendation for any of them. For additional information on the use of XBRL software, please consult the manuals and documentation that accompany the software. Additionally, the XBRL US, Inc. website (www.xbrl.us) provides a listing of XBRL software vendors. XBRL US, Inc. is an independent non-profit organization that does not recommend, promote, or profit from any individual vendors or products. The selection of software is the sole responsibility of the preparer.

The guidance in this document, and XBRL itself, does not in any way affect, alter, or eliminate the preparer's responsibility for the accuracy of all financial statements under a preparer's purview. As with printed financial statements, preparers and other immediate stakeholders are ultimately responsible for everything that appears in XBRL-encoded statements ([instance documents](#)). The decision makers at each step in the XBRL creation process should take care to understand XBRL as it relates directly to these responsibilities.

When used correctly, XBRL does not alter the meaning of financial statements, but only their appearance and mechanism of delivery. This guide is not authoritative accounting literature, and it does not affect US GAAP and US Securities and Exchange Commission (SEC) financial reporting disclosure requirements. It neither sets nor amends any standards or requirements. The guide exists to help preparers to learn about XBRL as it relates to financial statements and to promote consistency in the way financial statements are formatted using XBRL. To this end, it identifies rules for the preparation of XBRL extension taxonomies and instance documents using highlighted text and a graphic marker. An example of a rule:

Rule: Do not change element definitions or references in the XBRL US GAAP Taxonomy.



Violating *rules* has a variety of undesirable consequences, depending on the rule:

1. An extension taxonomy or instance document may be unusable because it is not valid XBRL, or may be rejected by the EDGAR system.
2. An instance document and extension taxonomy may be incomplete, missing information that users need to understand and correctly interpret the financial statements.
3. An instance document may contain inconsistent information, not all of which can be detected automatically by XBRL software, but which will be visible to analysts and users.

There are also rules of thumb for preparers. An example of a rule of thumb:

Rule of Thumb: Validate the extension taxonomy often to avoid spending time fixing errors at the end of the process.



Violating *rules of thumb* usually hurts preparers more than other users:

1. The extension taxonomy may be unnecessarily difficult to create and use, with internal inconsistencies that make it difficult or impossible to use to create an instance document.
2. The extension taxonomy may require substantial modifications every period, increasing cost to the preparer.
3. The extension taxonomy may be missing information or have ambiguities that increase the likelihood of errors in the instance document, resulting in rework and multiple rounds of review, increasing cost to the preparer.

XBRL is a rapidly evolving language for financial reporting, and, although this guide will be updated to reflect any pertinent changes, XBRL US, Inc. cannot guarantee that the guidance herein is current on an up-to-the-minute basis. Check the Securities and Exchange Commission website (www.sec.gov) for the latest updates on XBRL-related financial reporting responsibilities and the XBRL US, Inc. website (www.xbrl.us) for the latest updates on XBRL specifications, taxonomies, software, services, and other developments.

Table of Contents

1	What is XBRL?.....	1
1.1	Overview of XBRL.....	2
1.1.1	Step 1 – Financial Statement Mapping.....	3
1.1.2	Step 2 – Extension Taxonomy Creation	4
1.1.3	Step 3 – Instance Document Creation	4
1.1.4	Step 4 – Review.....	5
1.1.5	Alternate Processes	5
1.2	Who Can Use XBRL?	5
1.3	Limits of XBRL	5
1.4	XBRL Terminology	6
2	Getting Started	7
2.1	Understanding and Assessing the Level of Effort	7
2.2	Assembling a Team	9
2.3	Resources and Tools	10
2.3.1	XBRL Software Functions.....	10
2.3.2	Third-Party Services	11
2.3.3	Learning Resources	11
3	Understanding and Using Taxonomies.....	13
3.1	What Are Taxonomies?.....	13
3.1.1	XBRL US GAAP Taxonomies v1.0	13
3.1.2	Component Folders	16
3.1.3	Industry Folders	16
3.1.4	More about Entry Points.....	17
3.1.5	Selecting the Industry and Reporting for Conglomerates	17
3.1.6	Non-GAAP Taxonomies	18
3.1.7	Anatomy of an Element.....	18
3.1.8	Relationships.....	24
3.1.9	Mapping Financial Statement Line Items to Elements	27
4	Using Taxonomy Calculations	32
4.1.1	What Calculations Do and Do Not Do	32
4.2	Rules that Define How Calculations Work	33
4.2.1	The Population of Facts.....	33
4.2.2	Relationship Groups	33
4.3	Calculation Weights	34
5	Using Tables	36
5.1	Table Elements and Relationships	38
5.1.1	Line Items Abstract Element	38
5.1.2	Table Element	39
5.1.3	Axes Are Children of Table Elements	39
5.1.4	A Domain Is a Child of an Axis	39
5.1.5	Domain Members Are Children of a Domain	39
5.1.6	Line Items Are Children of the Line Items Abstract Element.....	39
5.1.7	Each Domain Element Is the Default Member of an Axis.....	39
5.1.8	Calculations within Tables	40
5.1.9	Presentation of a Table	40
5.1.10	Rotating Axes.....	41
5.1.11	Tables with More Axes	42
5.1.12	Mapping to Tables	43
6	Creating Extensions	44
6.1	Method 1: Create Relationship Groups.....	45
6.2	Method 2: Change the Ordering of Relationships.....	45
6.3	Method 3: Change the Preferred Label Used on a Presentation Relationship	46
6.4	Method 4: Add a New Abstract Heading Element to Group Elements into Presentation Relationships.....	48
6.5	Method 5: Add or Change Element Labels	50
6.6	Method 6: Add a New Relationship between Elements.....	54
6.6.1	Add Calculation Relationships into Statements.....	54

6.6.2	Add Dimensional Relationships into Statements	58
6.6.3	Add Presentation Relationships into Statements.....	65
6.6.4	Add Presentation Relationships into Notes.....	71
6.6.5	Add Dimensional Relationships into Notes.....	75
6.6.6	Add Calculation Relationships into Notes.....	77
6.7	Method 7: Suppress or Change a Parent-Child Relationship in the XBRL US GAAP Taxonomy	78
6.8	Method 8: Add a New Domain Member Element to an Existing Table Domain	78
6.9	Method 9: Add a New Axis to an Existing Table.....	79
6.10	Method 10: Add a New Table	81
6.11	Method 11: Add a New Numeric Element Such as a Monetary, Per-share, or Other Amount	84
6.12	Method 12: Add a New String, Text Block, Date, or Other Non-numeric Element.....	88
7	Creating Instance Documents.....	90
7.1	How Do Taxonomies and Instance Documents Work Together?	90
7.2	What Is Included in an Instance Document?.....	92
7.2.1	Tags	92
7.2.2	Contexts.....	93
7.2.3	Entity Information.....	94
7.2.4	Period Information	94
7.2.5	Axes and Domain Members	94
7.2.6	Context ID	94
7.3	Units and Measures	95
7.4	Decimals (and Precision)	95
7.5	Tagging Values	96
7.5.1	Capturing the Full Value/Scaling.....	96
7.5.2	Sign Values and the Balance Type	96
7.5.3	Tables	97
7.6	Understanding Cash Flow and Calculations	100
7.6.1	Zero and Nil	102
7.7	XBRL Footnotes.....	102
7.8	Validating the Instance Document.....	103
7.8.1	Calculation Consistency.....	103
7.8.2	Validation Software	104
8	Review of Instance Documents	105
8.1	Management's Responsibilities and Review Objectives	105
8.1.1	Accuracy and Completeness of Mapping	106
8.1.2	Accuracy and Completeness of Tagging	106
8.1.3	Accuracy of Context Assignments	106
8.1.4	Accuracy and Appropriateness of Relationships in the Extension.....	106
8.2	Validation	107
8.3	Review and Approval	107
	Appendix A: Glossary	108
	Appendix B: SIC code Mapping to Industry Entry Point	113
	Appendix C: Extension Naming and files.....	114
	Appendix D: Terminology in the XBRL US GAAP Taxonomy	116
	Appendix E: Validation.....	117
	Appendix F: Websites for XBRL Preparers	119

Table of Figures

Figure 1	Sample Income Statement.....	1
Figure 2	XBRL Extension Taxonomy and Instance Document Creation Process	3
Figure 3	Mapping of a Balance Sheet	4
Figure 4	Simple PP&E Note Example	7
Figure 5	Tagging an Entire Note as a Text Block	8
Figure 6	Tagging a Note Narrative and Table as Text Blocks.....	8
Figure 7	Tagging a Note Table in Detail	8

Figure 8 Tagging Facts in the Narrative Text of a Note.....	9
Figure 9 Note Tagging Levels.....	9
Figure 10 Folder Organization of the XBRL US GAAP Taxonomies v1.0	15
Figure 11 Four Entry Points per Industry	17
Figure 12 Anatomy of an Element.....	18
Figure 13 Element Attributes	19
Figure 14 Multiple Labels with a Roll-Forward.....	20
Figure 15 Label Types, with Examples of Each.....	20
Figure 16 Element Definition Example.....	21
Figure 17 Abstract Element as Heading	21
Figure 18 Data Types Most Frequently Occurring	22
Figure 19 Authoritative Reference Sources.....	23
Figure 20 Relationships.....	24
Figure 21 ABC Company and Subsidiaries Current Assets, Presentation Relationships.....	25
Figure 22 Presentation vs. Calculation Relationships for ABC Company and Subsidiaries	25
Figure 23 Example of an Inconsistency in an Instance Document	26
Figure 24 No Reported Fact, No Inconsistency	26
Figure 25 Extension with Calculation Relationships Eliminating Inconsistency	26
Figure 26 Dimensions Example (Dimensional Relationships)	27
Figure 27 Dimensions Example, Different Original (Dimensional Relationships)	27
Figure 28 Data Type Attribute Examples.....	30
Figure 29 Calculation Example (shown in Presentation Relationships)	32
Figure 30 Deposits Example (Preparer’s Original Layout)	33
Figure 31 Deposits Example, Presentation and Calculation Relationships	34
Figure 32 Calculation Weights (Calculation Relationships)	34
Figure 33 Table of Calculation Relationship Weight Rules	35
Figure 34 Calculation Relationship Weights Example	35
Figure 35 XYZ Company and Subsidiaries, Available-for-Sale Securities Reconciliation of Fair Value (Original Preparer Layout).....	36
Figure 36 Elements of a Table.....	37
Figure 37 XYZ Company and Subsidiaries, Available-for-Sale Securities Reconciliation of Fair Value (Published Financial Statement View with Table Overlay)	38
Figure 38 Parent-Child Table Structure in Dimensional Relationships	38
Figure 39 Available-for-Sale Securities Table in the XBRL US GAAP Taxonomy (Dimension Relationships)	40
Figure 40 Available-for-Sale Securities Table in the XBRL US GAAP Taxonomy (Tabular)	40
Figure 41 Available-for-Sale Securities Table in the XBRL US GAAP Taxonomy (Presentation Relationships)	41
Figure 42 ABC Company and Subsidiaries, Note 3: Marketable Debt and Equity Securities	41
Figure 43 Schedule of Entity-Wide Revenue by Major Customers, by Reporting Segments (Dimension Relationships with Entity-Specific Extensions)	42
Figure 44 Using Multiple Axes in Alternative Layouts	42
Figure 45 Methods of Extending a Taxonomy	44
Figure 46 Suggested New Relationship Groups	45
Figure 47 Extension Taxonomy Validation Messages about Relationship Groups.....	45
Figure 48 Reordering Children	46
Figure 49 Validation Messages about Presentation Relationships	46
Figure 50 Example of Preferred Labels, with Impact on Displayed Data	47
Figure 51 Extension Taxonomy Validation Messages about Preferred Labels	48
Figure 52 An Abstract Element Created in an Extension	48
Figure 53 Attributes of an Abstract Element.....	49
Figure 54 Extension Taxonomy Validation Messages about New Abstract Elements	49
Figure 55 Sample of Element Labels in Extension Taxonomies	51
Figure 56 Element Standard Labels Largely Changed by an Extension.....	52
Figure 57 Element Standard Labels Left Mostly Unchanged	53
Figure 58 Extension Taxonomy Validation Messages about Labels and References	54
Figure 59 Moving an Element Out of a Subtotal	55
Figure 60 Using a Concept from a Disclosure.....	56
Figure 61 Moving an Element Out of a Subtotal Involving Negative Weights	57

Figure 62 Extension Taxonomy Validation Messages about Calculations.....	58
Figure 63 Common Domain Members (Dimensional Relationships)	59
Figure 64 Statement of Financial Position, Classified (Dimensional Relationships)	59
Figure 65 Fragment Containing Previously Reported, Adjusting, and Restated Data	60
Figure 66 Statement (Dimensional Relationships)	60
Figure 67 Balance Sheet Fragment Containing Historical and Planned Data.....	60
Figure 68 Multiple Reports of the Same Statement (Dimensional Relationships)	61
Figure 69 Balance Sheet Fragment with Multiple Entities.....	61
Figure 70 Multiple Entities (Dimensional Relationships).....	62
Figure 71 Balance Sheet Fragment with Multiple Stock Classes	62
Figure 72 Multiple Stock Classes (Dimensional Relationships)	63
Figure 73 Statement of Equity Example, with Components of Equity.....	64
Figure 74 Validation Messages about Dimensional Relationships.....	64
Figure 75 Technical Details of Parent-Child Structure in Tables (Dimensional Relationships)	65
Figure 76 Topmost Elements for the Presentation Relationship Groups.....	65
Figure 77 Presentation vs. Calculation Relationships (Balance Sheet) ABC Company and Subsidiaries	66
Figure 78 Presentation vs. Calculation Relationships (Income Statement, ABC Company and Subsidiaries)	67
Figure 79 Presentation Relationships with Standard Labels, Cash Flow Statement for ABC Company and Subsidiaries	67
Figure 80 Statement of Partners' Capital (Selected Presentation Relationships)	68
Figure 81 Statement of Other Comprehensive Income, Presentation Relationships with Parentheticals and Standard Labels, ABC Company and Subsidiaries.....	69
Figure 82 Presentation and Calculation Relationships, Cash Flow Statement of ABC and Subsidiaries.	70
Figure 83 Alignment of Dimensional and Presentation Relationships	70
Figure 84 Text Blocks Near the Top of Disclosure Relationship Groups (Presentation Relationships)...	72
Figure 85 ABC Company and Subsidiaries Notes Mapped to Text Block Elements	72
Figure 86 Plain vs. Formatted Text	73
Figure 87 Elements in Receivables, Loans, Notes Receivable, and Others (Presentation Relationships)	74
Figure 88 Accounts Receivable Note, ABC Company and Subsidiaries, Original Layout.....	75
Figure 89 Accounts Receivable Note, ABC Company and Subsidiaries (Presentation Relationships)	75
Figure 90 Example of a Restatement in a Disclosure.....	76
Figure 91 Deposits Example, Repeated.....	77
Figure 92 Attributes of a Domain Member Element.....	79
Figure 93 Long-lived Assets Held-for-sale, with New "Location" Axis (Dimensional Relationships).....	80
Figure 94 Attributes of an Axis Element.....	80
Figure 95 Attributes of a Domain Element.....	81
Figure 96 Extension Taxonomy Validation Messages about New Axis and Domain Elements	81
Figure 97 Attributes of a Table Element.....	82
Figure 98 Attributes of a Line Items Element.....	83
Figure 99 Attributes of a Table Text Block Element	83
Figure 100 Extension Taxonomy Validation Messages about New Tables.....	84
Figure 101 Liabilities and Minority Interest, a Subtotal Element	85
Figure 102 Attributes of Liabilities and Minority Interest, a Monetary Element	85
Figure 103 Presentation and Calculation Relationships, Liabilities and Minority Interest	86
Figure 104 Cash Flows from Financing Activities with Detail Line Items	86
Figure 105 Attributes of Principal Payments on Debt Excluding Amortization Element.....	87
Figure 106 Presentation and Calculation Relationships, Repayments of Secured Debt, Excluding Amortization	87
Figure 107 Extension Taxonomy Validation Messages about New Numeric Elements	88
Figure 108 Issuance of Stock by Equity Method Investees, Element.....	88
Figure 109 XBRL Instance Document Creation Process	91
Figure 110 Examples of Information To Be Tagged.....	92
Figure 111 ABC Company's Current Assets, with Elements Mapped	92
Figure 112 Contexts	93
Figure 113 Example Context Naming Convention	95
Figure 114 Example Units Naming Convention.....	95
Figure 115 Defining a "Stores" Unit	95

Figure 116 Disclosure Example Using a Table	97
Figure 117 Line Items, Domains, and Domain Members in a Table	98
Figure 118 Facts in a Table.....	99
Figure 119 Contexts in a Table.....	100
Figure 120 ABC Company – Net Cash Provided (Used) by Operating Activities (Calculation Relationships)	101
Figure 121 ABC Company – Net Cash Provided (Used) by Operating Activities (Presentation Relationships)	101
Figure 122 Footnote Example	103
Figure 123 Rounding	103
Figure 124 Two Calculation Inconsistencies from Five Years of ABC Company Data	104
Figure 125 SIC Codes with Suggested Industry Entry Points.....	113
Figure 126 Namespace Examples	114
Figure 127 Relationship File Abbreviations	115
Figure 128 Spelling Used in Preference to Alternative Spellings.....	116
Figure 129 FRTA 1.0 Rule Waivers.....	118

1 WHAT IS XBRL?

XBRL, eXtensible Business Reporting Language, is an XML-based markup language used to communicate financial and business data electronically. Although XBRL is based on XML, XBRL software is generally user-friendly, requiring no previous knowledge of XML and no IT background. Any entity can use XBRL to encode its financial information such as financial statements, earnings releases, and so forth. In simple terms, XBRL is a tool that benefits all users of financial statements by providing increased functionality over traditional paper, Hyper Text Markup Language (HTML), and other image-based financial reporting formats.

XBRL is used to encode financial statements so that the information in those statements can be read automatically by XBRL-enabled software and more easily sorted and compared. Computers have no inherent knowledge of financial reporting and do not understand information that is not fully defined. Making information machine-readable requires data to be accompanied by contextual information. Consider the example in Figure 1. Telling a computer "our net sales were 131,383" is useless without defining what the number represents (net sales), the currency in which it is reported (dollars), scaling and rounding (thousands), time period covered (2013), and the company identity (ABC Company). This accompanying context allows a computer to make sense of "131,383". The markup codes used in XBRL describe financial data in a format that computers can classify, sort, and analyze.

Figure 1 Sample Income Statement

ABC COMPANY AND SUBSIDIARIES		
Consolidated Statements of Income		
For the Two Years Ended December 31, 2013 and 2012		
<i>(In thousands, except share data)</i>		
	2013	2012
Net Sales	\$ 131,383	117,131
Costs of goods sold	117,885	103,333
Gross profit	13,498	13,798
Selling, general, and administrative expenses	11,223	10,707
Other (income) expense	(278)	(138)
Interest expense	1,420	1,033
Income Before Income Taxes	1,133	2,196
Income Tax Benefit	(236)	(524)
Net Income	\$ 1,369	2,720
Earnings Per Common Share	\$ 0.27	0.53

XBRL facilitates the analysis of financial data by using pre-existing names to standardize business reporting terminology. Companies often use different terms to describe the same concepts (for example, "accounts receivable", "receivables", and "trade [accounts] receivable"). XBRL normalizes company-specific terminology to get to the root business reporting concepts, allowing comparison of essentially similar information across multiple financial statements and among multiple companies.

XBRL in no way requires a company to change how, what, or when to report financial information. It simply provides a standard mechanism for computers to understand and compare financial data. XBRL also does not change or add to US [GAAP](#) and SEC financial reporting disclosure requirements; it is strictly a method of transmitting financial information in a way that leverages computer technology. The XBRL US GAAP Taxonomy is not an accounting guide or disclosure checklist. Using the taxonomy as the basis for preparation of a financial statement provides no assurance that the financial statements comply with US GAAP or meet all of the reporting requirements set forth by regulators. Compliance with US GAAP and reporting requirements should be determined independently from the information contained in the XBRL US GAAP Taxonomy.

1.1 Overview of XBRL

Markup tags have been used since the 1960s to assign appearance and organizational characteristics to electronic documents and, with the advent of the Internet, website content. Similarly, XBRL assigns each financial statement item a tag to give it a machine-readable meaning. The number “131,383” thus becomes ABC Company and Subsidiaries’ \$131 million of consolidated net revenue for 2013. To perform tagging, preparers must have a collection of previously defined [elements](#) that provide the definitions that computers use to understand financial statement data. These collections of defined elements are called [taxonomies](#). To create XBRL-encoded financial statements, preparers match each piece of information from the financial statements to an element in the taxonomy. During this matching process, known as [mapping](#), preparers note where the taxonomy differs from the financial statements. In such cases, preparers “extend” the XBRL US GAAP Taxonomy by relabeling elements, rearranging elements, or creating new elements to match the financial statements. Once preparers have a fully mapped financial statement and extend the XBRL US GAAP Taxonomy to match the financial statements, they can then tag each piece of financial statement information to create an XBRL-encoded financial statement known as an [instance document](#). These instance documents must be reviewed before they are released.

Figure 2 presents the basic work flow for creating XBRL-encoded financial statements. The process starts with a complete set of US GAAP compliant financial statements and ends with a valid [extension taxonomy](#) and instance document. The first step of the process is mapping the financial statements to the latest version of the taxonomy that contains the standard definitions and structure that most closely reflect the financial statements. Preparers must check the XBRL US website before mapping to ensure that the taxonomy used is the most recent.

This process is based on current practice, in which the financial statement is prepared before the XBRL extension creation or instance document tagging begins. Integrating the extension taxonomy creation into the preparation process for the financial statements offers advantages, and future editions of this guide will address methods for a more integrated process.

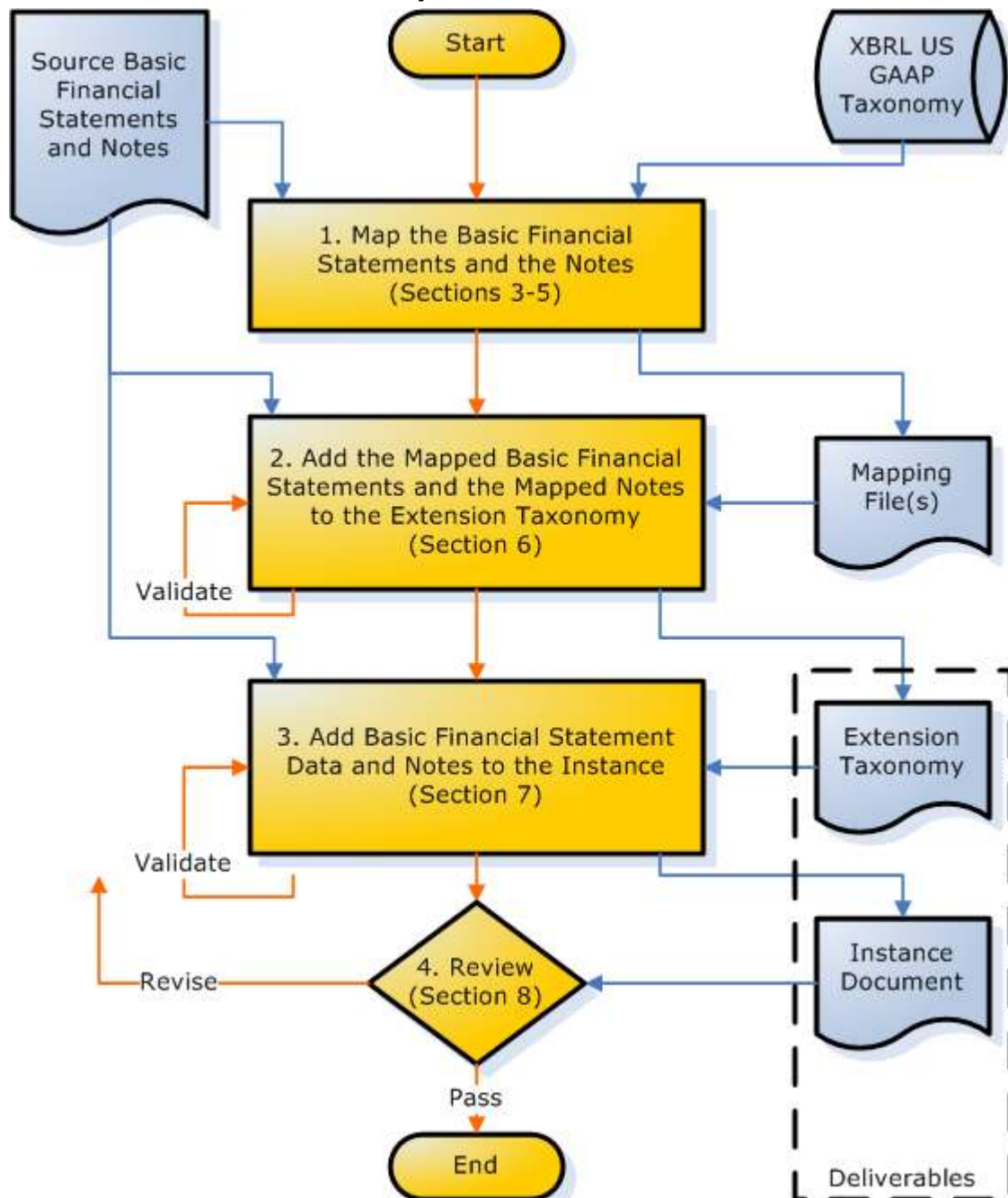
Figure 2 XBRL Extension Taxonomy and Instance Document Creation Process

Blue indicates Information and Information Flow;
Orange indicates Process and Process Flow

1.1.1 Step 1 – Financial Statement Mapping

Mapping can be done in a number of ways, but when mapping for the first time, preparers might consider using either a spreadsheet or a simple pen-and-paper table, listing financial statement concepts in one column and corresponding taxonomy elements in another. Using familiar tools to map can help preparers to learn the taxonomy and see where they need to extend the taxonomy to meet specific reporting needs. Figure 3 provides an example of what a template for mapping might look like for the balance sheet of ABC Company. The left column shows the statement line items; the middle shows the mapped element name; and the right indicates additional details about the line item.

Mapping, which is necessary for financial statements including notes, is covered starting with [Section 3, Understanding and Using Taxonomies](#), with additional supporting detail in [Section 4, Using Taxonomy Calculations](#), and in [Section 5, Using Tables](#).

Figure 3 Mapping of a Balance Sheet

	Financial Statement as Prepared	XBRL US GAAP Taxonomy Element	Remarks
1	Assets	AssetsAbstract	
2	Current Assets:	AssetsCurrentAbstract	
3	Cash and cash equivalents	CashAndCashEquivalentsAtCarryingValue	
4	Marketable debt and equity securities (Note 3)	MarketableSecuritiesCurrent	
5	Accounts receivable (Note 4)	ReceivablesNetCurrent	
6	Inventories (Note 5)	InventoryNet	
7	Current deferred tax assets (Note 12)	DeferredTaxAssetsNetCurrent	
8	Other current assets	OtherAssetsCurrent	
9	Total Current Assets	AssetsCurrent	Total of 4..8
10	Property, Plant, and Equipment at cost, net (Note 6)	PropertyPlantAndEquipmentNet	
11	Deferred Tax Assets (Note 12)	DeferredTaxAssetsNetNoncurrent	
12	Other Assets (Note 7)	OtherAssetsNoncurrent	
13	Total Assets	Assets	Total of 9+10..12
14			
15	Liabilities and Stockholders' Equity	LiabilitiesAndStockholdersEquityAbstract	
16	Current Liabilities:	LiabilitiesCurrentAbstract	
17	Short-term borrowings (Note 8)	ShortTermBorrowings	
18	Current maturities of long-term debt (Note 9)	LongTermDebtCurrent	
19	Accounts payable, Trade	AccountsPayable	
20	Accrued payroll and employee benefits	EmployeeRelatedLiabilities	
21	Other accrued liabilities	AccruedLiabilities	
22	Total Current Liabilities	LiabilitiesCurrent	Total of 17..21
23	Long-Term Debt (Note 9)	LongTermDebtNoncurrent	
24	Other Long-Term Liabilities	OtherLiabilitiesNoncurrent	
25	Total Liabilities	Liabilities	Total of 22..24
26	Commitments and Contingent Liabilities (Note 14)	CommitmentsAndContingencies	Not numeric
27	Stockholders' Equity (Note 10):	StockholdersEquityAbstract	
28	Class A Common stock, issued 5,094,370 shares in 2013 and 5,089,370 shares in 2012	CommonStockValue	
29		CommonStockSharesIssued	Parenthetical
30	Paid-in capital	AdditionalPaidInCapitalCommonStock	
31	Retained earnings	RetainedEarningsAccumulatedDeficit	
32	Accumulated other comprehensive income	AccumulatedOtherComprehensiveIncomeLossNetOfTax	
33	Treasury stock-at cost, Class A Common stock, 128,000 shares	TreasuryStockValue	
34		TreasuryStockShares	Parenthetical
35	Total Stockholders' Equity	StockholdersEquity	Total of 28,30..33
36	Total Liabilities and Stockholders' Equity	LiabilitiesAndStockholdersEquity	Total of 25+35

1.1.2 Step 2 – Extension Taxonomy Creation

After mapping the financial statements and identifying areas requiring an extension to the XBRL US GAAP Taxonomy, a preparer does not change the XBRL US GAAP Taxonomy directly. Instead, an extension taxonomy is created “on top” of the XBRL US GAAP Taxonomy with all the changes required for an entity’s specific reporting needs. Extending the taxonomy properly makes it reusable with only slight modifications period after period. Taxonomy extension is discussed in greater detail in [Section 6, Creating Extensions](#).

Validating the extension taxonomy will check it for technical errors and inconsistencies. XBRL software is used to validate extensions, so a preparer should select a software product that has an effective validation function. Frequent validation diminishes the possibility of finding downstream errors late in the process. Validation of the taxonomy is important because it will impact the validation of the instance document (step 3).

1.1.3 Step 3 – Instance Document Creation

After adding the extension taxonomy to the XBRL US GAAP Taxonomy to fit the financial statements, the preparer is ready to create an XBRL instance document. The instance document contains entity-specific financial data for a specific period and ties them to the XBRL standard definitions and other

descriptive data in the taxonomy. The instance document also contains other specific financial report information such as the company to which the data apply, the period being reported, whether the information is consolidated, restated, and so forth. Instance documents are discussed in detail in [Section 7, *Creating Instance Documents*](#).

Validation of the instance document checks whether it is consistent with the extension taxonomy. XBRL software is used to validate the instance document, so a preparer must select software that has an effective validation function for instance documents.

1.1.4 Step 4 – Review

The valid extension taxonomy and instance document are the deliverables of this process. Review of the mapping files, extension taxonomy, and instance document during the development process is desirable, but at a minimum the deliverables must be reviewed and reworked if not satisfactory. Management is responsible for the completeness, accuracy, and presentation of financial statements whether the financial statements are paper-based or in XBRL. For example:

- **Completeness:** Do all the statements, amounts, notes, and text from the source document appear in the instance document?
- **Accuracy:** Are all the numeric values in the instance document the same as the source document?
- **Presentation:** Are the relationships in the instance document consistent with relationships in the source document?

[Section 8, *Review of Instance Documents*](#), addresses the topic further.

1.1.5 Alternate Processes

There are a number of possible work flows to create an extension taxonomy and instance document.

For example, completing the extension taxonomy for the statements and notes before starting the instance document helps to ensure consistent tagging when the same amounts appear on different pages. However, an alternative is to complete the face of the financial statements in their entirety, which populates the instance document with a single period of data from the basic statements and can reveal problems in the extension that can be corrected early.

Also, the features and functions of XBRL software that preparers use will affect the work flow, possibly condensing or expanding certain steps. The preparer must decide what processes to use based on available tools and experience.

1.2 Who Can Use XBRL?

Anyone involved in business reporting can use XBRL: preparers on the internal accounting and financial statement creation end; analysts and investors on the financial statement consumer end; and everyone in between, such as auditors and data aggregators. While this document focuses solely on the preparer, XBRL has benefits for all financial information stakeholders.

1.3 Limits of XBRL

XBRL combines web-based technology with standardized terms and definitions to provide increased functionality for users of financial statements, including improved data comparability and the many advantages of having financial statements in a reusable, computer-readable format. XBRL can provide more timely and efficient analysis of financial data internally and across companies, expand usability of externally reported financial information, and improve cost accounting, performance measurement, and overall decision making. However, it is *not* a substitute for the financial accounting systems, controls, procedures, and related managerial oversight required to prepare GAAP-compliant financial statements. XBRL improves the usability and comparability of financial statement information, but it does not check the accuracy of financial statements for compliance with accounting standards, including company decisions with respect to when, how, and at what value transactions are reported and disclosed within those financial statements. Financial statements derived from XBRL instance documents are only as reliable as the financial information used and the accuracy of the mapping used to create them.

XBRL is an enhancement of traditional modes of financial reporting. It does not provide more data than standard financial statements; it provides the data in a format that computers can sort, group, and categorize. When used correctly, XBRL changes the appearance and improves the delivery mechanism for financial statements, but it does not alter their meaning.

1.4 XBRL Terminology

A basic knowledge of XBRL terminology is essential to understanding XBRL and creating financial reports in XBRL. XBRL term definitions can be found in the Glossary ([Appendix A](#)) and via hyperlinks throughout this guide.

2 GETTING STARTED

Creating an instance document for the first time is often time and labor intensive because preparers are acclimating not only to taxonomy elements and tagging, but to the overall process involved. Before getting started, preparers should assess the required level of effort, the tools available, and the roles of team members.

2.1 Understanding and Assessing the Level of Effort

Determining the level of effort involved in any new initiative can be difficult. Becoming familiar with XBRL and with the XBRL experiences of others before attempting to implement it will help preparers to estimate the resources required.

Perhaps the most effective way to gauge the effort involved in instance document creation is to create a brief instance document based on a small portion of a financial statement. This type of practice run will familiarize preparers with the XBRL US GAAP Taxonomy and tagging, give a feel for the process, and provide a better perspective on how much time will be required to tag the full set of financial statements.

Key to understanding the level of effort is determining the number of individual pieces of data that need to be tagged. For the [face of the financial statements](#), start with these two rules:

Rule: Tag each line item on the face of the financial statements.



Rule: Tag separately amounts such as "allowance for doubtful accounts" or "shares authorized, issued and outstanding" that appear parenthetically.



Tagging the notes to the financial statements is more difficult to estimate due to the different levels of detail involved, as illustrated using a simple PP&E Note (Figure 4):

1. Tagging an entire note as a text block (Figure 5).
2. Tagging a note narrative and table as text blocks (Figure 6).
3. Tagging a note table in detail (Figure 7).
4. Tagging facts in the narrative text for a note (Figure 8).

Tagging at the individual note level as a single block of text is the minimum level of detail to be tagged.

Rule: At a minimum, tag all the information in every note in text blocks.



Figure 4 Simple PP&E Note Example

10. Net Property and Equipment		
Net property and equipment consists of the following (in thousands):		
	2007	2006
Land	\$ 31,659	\$ 31,601
Buildings and improvements	79,726	79,696
Leasehold improvements	84,737	76,606
Equipment and other	203,532	193,117
Construction in progress	8,420	5,377
	408,074	386,397
Less accumulated depreciation and amortization	(209,117)	(188,675)
Net property and equipment	<u>\$ 198,957</u>	<u>\$ 197,722</u>

Depreciation and amortization expense was \$20.4 million in 2007 and \$18.2 million in 2006. These amounts included amortization expense for leased property under capital leases.

Figure 5 Tagging an Entire Note as a Text Block

Element	Value
Property, Plant and Equipment Disclosure [Text Block]	<p>10. Net Property and Equipment Net property and equipment consists of the following (in thousands):</p> <p>2007 2006 Land 31,659 31,601 Buildings and improvements 79,726 79,696 Leasehold improvements 84,737 76,606 Equipment and other 203,532 193,117 Construction in progress 8,420 5,377 408,074 386,397 Less accumulated depreciation and amortization (209,117) (188,675) Net property and equipment 198,957 197,722</p> <p>Depreciation and amortization expense was \$20.4 million in 2007 and \$18.2 million in 2006. These amounts included amortization expense for leased property under capital leases.</p>

Figure 6 Tagging a Note Narrative and Table as Text Blocks

Element	Value
Notes to Financial Statements [Abstract]	
Property, Plant and Equipment Disclosure [Text Block]	<p>10. Net Property and Equipment Net property and equipment consists of the following (in thousands):</p> <p>Depreciation and amortization expense was \$20.4 million in 2007 and \$18.2 million in 2006. These amounts included amortization expense for leased property under capital leases.</p>
Property, Plant and Equipment [Text Block]	<p>2007 2006 Land 31,659 31,601 Buildings and improvements 79,726 79,696 Leasehold improvements 84,737 76,606 Equipment and other 203,532 193,117 Construction in progress 8,420 5,377 408,074 386,397 Less accumulated depreciation and amortization (209,117) (188,675) Net property and equipment 198,957 197,722 Depreciation and amortization expense was \$20.4 million in 2007 and \$18.2 million in 2006. These amounts included amortization expense for leased property under capital leases.</p>

Figure 7 Tagging a Note Table in Detail

Domain Member	Line Item Element	2007-12-30	2006-12-31
Land [Member]	Property, Plant and Equipment, Gross	31,659,000	31,601,000
Building and Building Improvements [Member]	Property, Plant and Equipment, Gross	79,726,000	79,696,000
Leasehold Improvements [Member]	Property, Plant and Equipment, Gross	84,737,000	76,606,000
Equipment [Member]	Property, Plant and Equipment, Gross	203,532,000	193,117,000
Construction in Progress [Member]	Property, Plant and Equipment, Gross	8,420,000	5,377,000
Property, Plant and Equipment, Type [Domain]	Property, Plant and Equipment, Gross	408,074,000	386,397,000
	Accumulated Depreciation, Depletion and Amortization, Property, Plant and Equipment	209,117,000	188,675,000
	Property, Plant and Equipment, Net, Total	198,957,000	197,722,000

Figure 8 Tagging Facts in the Narrative Text of a Note

Element	2007	2006
Notes to Financial Statements [Abstract]		
Property, Plant and Equipment Disclosure [Text Block]	10. Net Property and Equipment Net property and equipment consists of the following (in thousands): Depreciation and amortization expense was \$20.4 million in 2007 and \$18.2 million 2006. These amounts included amortization expense for leased property under capital leases.	
Depreciation and Amortization	20,400,000	18,200,000

Of course, notes to the financial statements also include tables, numeric disclosures included in text, and multiple text disclosures. Figure 9 shows four levels of note tagging and what they include.

Figure 9 Note Tagging Levels

	Minimum	Level 2	Level 3	Level 4
Entire Text of Note as a Text Block	Yes	Yes	Yes	Yes
Narrative Text (not Tables) in Text Block(s)		Yes	Yes	Yes
Tables as Separate Text Blocks		Yes		
Individual Facts in Tables			Yes	Yes
Individual Facts Extracted from Narrative				Yes

Preparers should provide tagged information beyond the minimum requirements in order to improve the clarity and usability of the report. Nothing in this guide should be interpreted to *limit* the level of information companies choose to provide to investors.

Rule of Thumb: Tag all individual facts and disclosures within the notes to the financial statements that are potentially useful to users of the financial statements. 

Starting with a draft of the financial statements in a spreadsheet or other electronic document, preparers can then select and map the financial statement data (numeric and text) by associating the data with the appropriate taxonomy element.

Rule: Do not map an element to data that does not already appear on the financial statements. 

The amount of effort required to create instance documents should decrease for the preparer after the preparation of the initial instance document. Essential to reducing the effort is to create a good extension that can be reused in subsequent financial statements. The focus of this document is to help preparers make decisions that will result in a reusable extension. The first instance document may be challenging, but with this guidance, subsequent instance documents will become significantly easier and less time-consuming to prepare.

2.2 Assembling a Team

Diversity and skill management are essential in assembling an XBRL project team. The accuracy and completeness of XBRL documents are as important as those of any other financial report prepared for stakeholders. Treat XBRL as an integral part of the external financial reporting process. The same people—representing the same functional areas—who create the SEC filings should be involved in the XBRL effort.

In addition, because the initial use of XBRL can raise technical issues not found in traditional reporting, the team will need to have access to or develop a resource with XBRL knowledge who can help other team members with any process, software, or technological issues that arise.

Central to a company's XBRL team are the accountants and staff who create traditional financial reports. They are most familiar with the company's financial reporting and state of affairs and are thus uniquely qualified to evaluate which tags should be used in mapping.

Rule: Include the company's financial reporting accountants in the mapping and review processes to ensure proper representation of the company's financial statements.



In assembling a team to work on XBRL-encoded documents, bear in mind that XBRL is not a separate reporting function or an IT matter. XBRL financial reporting should be treated in the same manner as traditional "paper-based" reporting, and any stakeholders or participants involved in creating a company's traditional financial statements should be involved in creating XBRL-encoded reports. The same people who review the traditional financial statements before filing should also review the XBRL reports. For more information see [Section 8](#), *Review of XBRL Instance Documents*.

2.3 Resources and Tools

Numerous resources and tools exist to help preparers incorporate XBRL into financial statements. The XBRL US, Inc. website provides a listing and description of available products and services (www.xbrl.us/vendors/), including: software applications, instance document preparation, assistance with specific aspects of instance document creation, extension taxonomy creation, SEC filing, data aggregation, general consulting, and training. The site only lists products and services; XBRL US, Inc. does not evaluate or rate the providers. Types of resources and tools available to meet XBRL needs are discussed in further detail below.

2.3.1 XBRL Software Functions

Because XBRL is a software-based technology, preparers will need to use a software tool to apply the concepts discussed in this guide. To understand what software will be most helpful in working with XBRL, preparers must first understand the different software functions available. Some software tools include all required functionality for extension, validation, and instance document creation, whereas others offer this functionality separately or as part of a set. The particular situation and needs will determine which software preparers choose.

Taxonomy Creation and Extension

There are many elements and relationships in the XBRL US GAAP Taxonomy, but the nature of financial reporting will sometimes require preparers to extend these elements and relationships to meet specific needs. Taxonomy development tools allow preparers to create and manage extensions. Instance document creation software then uses the extension in instance documents.

Validation of Taxonomies

Taxonomy validation software allows preparers to validate different aspects of the extension for consistency and quality. It does not check whether preparers have used the correct tag or assigned the right numeric value to a tag, and it does not check the mathematical accuracy of the numeric values for a financial report.

Instance Document Creation

The simplest kind of instance document creation software allows preparers to create instance documents based on an existing taxonomy, such as the XBRL US GAAP Taxonomy or an extension of the taxonomy. Different types of instance document creation software vary greatly in complexity, functionality, and user friendliness, but most allow preparers to tag all types of financial data. Most users find that products that prevent them from entering invalid data and provide immediate feedback upon detection of an error or inconsistency are easier to use and produce better results more quickly.

Instance Rendering and Printing

While instance documents are designed primarily for computer application use, it is often necessary to view or print the instance document in a format that can be read. Instance documents are essentially lines of code containing text and numeric values surrounded by tags. They are comparable in concept

with web pages, which also have text surrounded by tags. And just as web browsers allow preparers to view HTML and XML documents in a simpler, more graphically oriented format, instance [rendering](#) software displays instance documents in an easier-to-understand format. Most instance rendering software allows preparers to view instance documents in a format that approximates the face of the financial statements. For example, an instance document representing a balance sheet displays similarly to the printed balance sheet.

There are limits on what can go into an XBRL document with respect to layout and formatting; for example, a lengthy note with paragraphs of text and tables may display without columns or run paragraphs together. Software solutions for rendering instance documents allow on-screen document viewing and printing, as well as manipulating the appearance and formatting of viewed and printed documents. However, the capabilities remain limited, and the views are custom solutions for each set of financials; no standard rendering and formatting solution currently exists for XBRL.

Comparative Analytics

One benefit of XBRL is increased comparability among financial statements. Standardized taxonomies and tags allow users to extract financial information across multiple statements, periods, and companies more easily than ever before. Software that reads instance documents and taxonomies can facilitate, manage, and even automate extraction and comparisons for users by reading the tags from financial statements and performing whatever data sorting users require.

Other Software Functions

Some software packages allow preparers to perform all of the previously discussed functions within the framework of a single program or suite of tools. These multifunction suites have the advantage of requiring preparers to learn the functionality of only one suite of tools.

XBRL is a markup language for financial reporting that can be used in numerous applications. Software tools that allow developers to integrate “plug-in” XBRL processing into commonly used applications already exist, and more tools that will facilitate the integration of XBRL into other applications will be introduced and constantly improved. Like any new technology, XBRL is fostering a great deal of creative application, and the types of software tools that will be developed in the near future will be limited only by market needs and developer creativity.

Regardless of what specific software preparers choose in working with XBRL to prepare financial statements, they should check with other users to see that the product fully supports the XBRL US GAAP Taxonomy. Remember that the ultimate responsibility for XBRL-encoded financial statements rests with the preparer. Preparers must read carefully any manuals or other documentation that accompanies the software to ensure proper taxonomy support.

2.3.2 Third-Party Services

Although preparers are ultimately responsible for all instance document content, they may choose to work with third-party service providers to assist in various aspects of the instance document creation process. If preparers use third-party providers, they must nevertheless review the work products (the extension taxonomy and instance document). Preparers are responsible for everything in an instance document; nothing in XBRL relieves preparers of the responsibility for financial reporting.

Rule: Review all extension taxonomies, instance documents, and other work products produced by third parties to ensure completeness and accuracy of the content.



To maintain appropriate oversight, preparers should understand and perform or manage as much of the XBRL-related work as possible. At the very least, mapping should be performed or thoroughly reviewed by the same individuals who prepare and review the company’s financial statements.

2.3.3 Learning Resources

Although this guide provides a basic working knowledge of XBRL concepts and terminology, it is not comprehensive and might not answer all of the questions preparers have about XBRL. [Appendix F](#) lists various XBRL resources that preparers can use to further understand more specific XBRL topics.

Manuals and other documentation that accompany XBRL software are also valuable resources, and preparers should consider getting formal training on any XBRL-related software that they use. This guide does not provide details of any particular tool or service, but training opportunities are listed at www.xbrl.us. The better preparers understand the software, the easier that instance document creation will be.

3 UNDERSTANDING AND USING TAXONOMIES

3.1 What Are Taxonomies?

A [taxonomy](#) is a description and classification system for concepts; an XBRL taxonomy is a particular way to describe and classify reporting concepts. XBRL represents each concept as an [element](#) with a name. The XBRL US GAAP Taxonomy describes and classifies elements representing US GAAP reporting concepts. XBRL taxonomies are electronic, machine-readable “dictionaries” consisting of many linked files containing thousands of elements linked to each other. The taxonomy contains human-readable [labels](#) such as financial statement line item captions, definitions, and applicable [authoritative references](#) for each element. The taxonomy specifies other [attributes](#) for elements, as described in greater detail later in this section.

The XBRL US GAAP Taxonomy is based on generally accepted accounting principles in the United States (US GAAP) and is intended for SEC registrants who file financial reports prepared in accordance with US GAAP. The XBRL US GAAP Taxonomy has broad and deep coverage of financial reporting concepts (over ten thousand elements) including all US GAAP and SEC financial statement disclosure requirements and many elements for commonly followed reporting practices. The taxonomy’s size and breadth minimizes the effort required to extend the taxonomies to meet specific reporting needs.

However, even if every line item on the face of the financial statements of a company had a corresponding element in the XBRL US GAAP Taxonomy, the preparer would still need to create an extension. This is because an extension taxonomy has more in it than just new elements to represent company-specific line items. It also specifies the form of statements (direct vs. indirect cash flow statement, for example), the ordering of line items, the disclosures that are relevant, the names of segments, and other reporting details. See [Section 6, Creating Extensions](#).

Although the XBRL US GAAP Taxonomies v1.0 will be maintained and updated to reflect changing US GAAP and SEC financial statement disclosure requirements, as well as changes in common reporting practice, providing for every reporting possibility would be impossible. Preparers should understand that:

- Meeting reporting requirements remains the registrant’s responsibility.
- The taxonomies should *not* be considered authoritative.
- The taxonomies do *not* create any authoritative guidance.
- The taxonomies should *not* be used as a GAAP disclosure checklist.

3.1.1 XBRL US GAAP Taxonomies v1.0

This guide focuses on the XBRL US GAAP Taxonomy, the main taxonomy that will be used for financial statement filings in the United States. The current release of the taxonomy was created through the organized efforts of XBRL US, Inc. with resources and input from members of XBRL US, public accounting firms, participants in the SEC’s Voluntary Financial Reporting Program, securities analysts, and others.

The XBRL US GAAP Taxonomy will be maintained and updated and will be available to the public on the XBRL US, Inc. website (www.xbrl.us). Annual revisions of the taxonomy are expected, with releases during the year for reasons such as the issuance of new FASB guidance or technical corrections. Although preparers are not responsible for maintaining and updating the XBRL US GAAP Taxonomy, they are responsible for using the latest version of the taxonomy.

Rule: Use the most up-to-date version of the XBRL US GAAP Taxonomy available on the XBRL US, Inc. website including any published extensions (releases).



The XBRL US GAAP Taxonomy is written in computer language, but preparers may view and read it by using publicly available software. In addition, instance documents of registrants participating in the SEC Voluntary Financial Reporting Program appear on the SEC website and may be viewed using one of the SEC’s free Interactive Financial Report Viewers, available along with other XBRL-enabled tools at www.sec.gov/xbrl.

The XBRL US, Inc. website publishes the official copies of several taxonomies, collectively referred to as the XBRL US GAAP Taxonomies v1.0, including:

- [XBRL US GAAP Taxonomy](#) – with several industry “[entry points](#)”:
 - Commercial and Industrial (“CI”)
 - Banking and Savings Institutions (“BASI”)
 - Broker-Dealer (“BD”)
 - Insurance (“INS”)
 - Real Estate (“RE”)
 - Other industries to be added in the future
- Non-GAAP Taxonomies
 - Document and Entity Information
 - Accountant’s Report on Financial Statements
 - Management’s Reports on Internal Control Over Financial Reporting
 - Officer Certification Required by SEC Exchange Act Rule 13a-14(a) or Rule 15d-14(a)
 - Management’s Discussion and Analysis (MD&A)

The term “[Non-GAAP](#)” in this guide simply means mandatory requirements outside of the core financial statements, notes, disclosures, and schedules; it does not mean “Non-GAAP measures” in the sense of Item 10(e) of Regulation S-K.

Figure 10 Folder Organization of the XBRL US GAAP Taxonomies v1.0

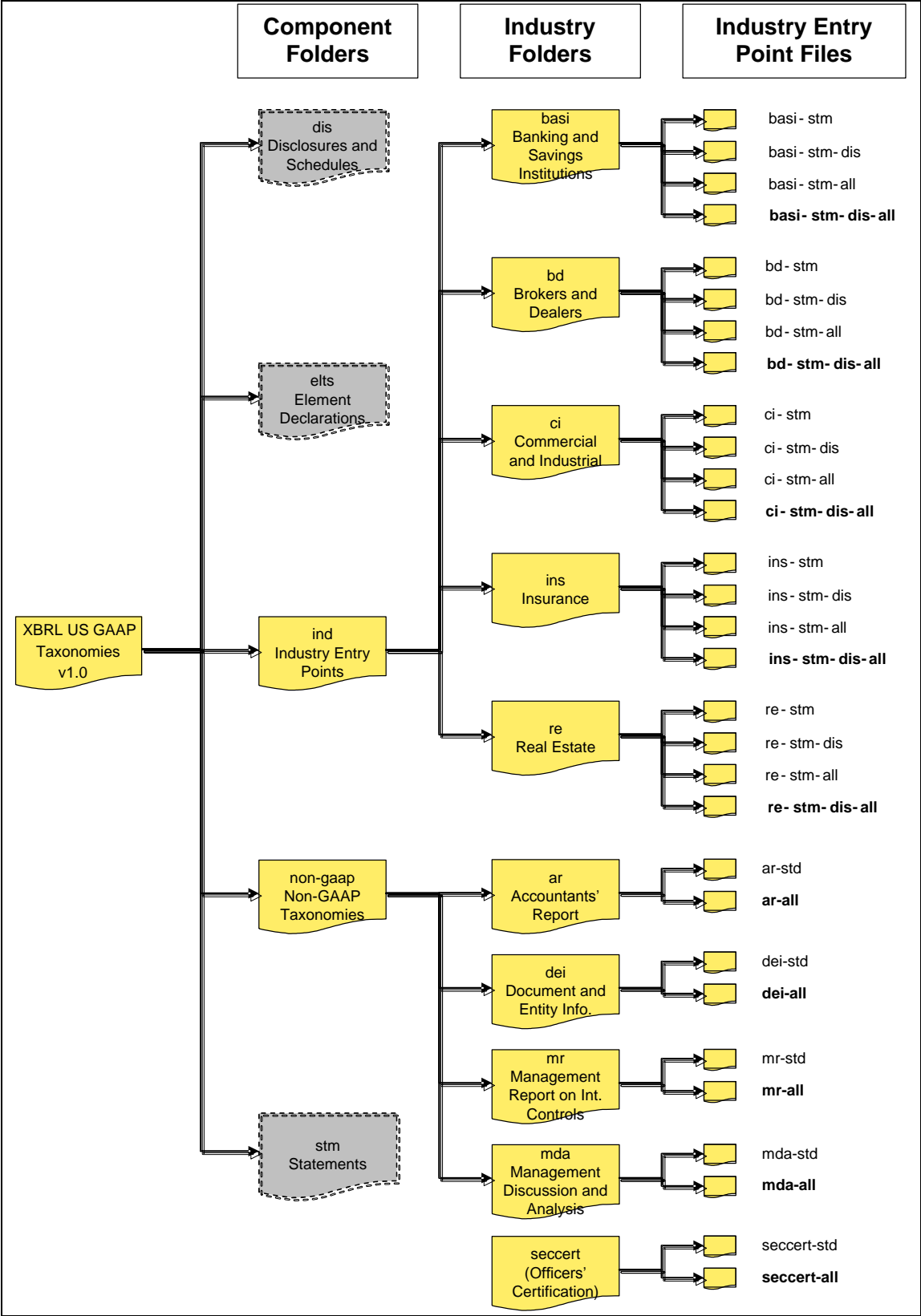

3.1.2 Component Folders

Of the five component folders shown in Figure 10, only two are designed for use directly by most preparers: the Non-GAAP Taxonomies (non-gaap) and Industry Entry Points (ind) folders. The Disclosures (dis), Elements Declarations (elts), and Statements (stm) folders have files containing fragments of the taxonomies that may be assembled into more compact sets of files by advanced users or tools.

3.1.3 Industry Folders

An “[entry point](#)” is an XBRL file that brings together a set of financial concepts that have common relationships. For example, the “insurance” entry point (ins-stm-dis-all) brings together financial concepts that are commonly used by insurance companies and organizes statements, disclosures, documentation, and references.

Companies in different industries report different combinations of financial concepts and different financial statement structures (for example, classified vs. unclassified balance sheets). To accommodate these differences, the XBRL US GAAP Taxonomy provides different entry points for the taxonomy content by industry. Preparers must decide which industry entry point is appropriate to map the face of the financial statements for their company. In general, the disclosures in the taxonomy do not vary by industry.

Opening an industry entry point with an XBRL tool loads the same complete list of ten thousand elements, regardless of the industry chosen. Industries organize elements into relationships that are common or typical for that particular industry. The relationships contained in an industry entry point will include not only the most commonly reported financial concepts, but also tangentially related concepts to accommodate companies that have operations that cross industries; for example, the Banking and Savings Institution (BASI) statements entry point shows “Premium Revenue”, which is generally considered to be an insurance industry concept.

A company’s financial statements may contain a line item that is not in the chosen industry statements, but that concept may appear in the taxonomy’s list of all elements. To ensure that it is the appropriate element, examine the relationships the element has in disclosures or statements of other industries; just as Microsoft® Office desktop products permit users to open and switch between different documents, all XBRL tools permit users to open several entry points at the same time. See [Section 6, Creating Extensions](#), for further details.

A loose analogy for this would be a form letter (entry point) and dictionary (list of all elements). The form letter uses a subset of the words in the dictionary, arranged for a particular purpose. Any words in the dictionary can be used to change the form letter, regardless of whether they appeared in the original.

To reduce efforts over the longer term, it is important to create an extension taxonomy that is reusable. The goal is to use the elements that most specifically describe the financial concept in the financial statements, while not being so specific that different elements would need to be identified or defined for different periods.

The XBRL US GAAP Taxonomy cannot provide for every reporting possibility in every industry. If it does not include an entry point that is specific to the reporting company’s industry, preparers should select the entry point that most closely reflects the financial statements. The Commercial and Industrial entry point, which includes financial reporting concepts for oil and gas, and utility entities, has the broadest coverage of the entry points and should be used as the default if preparers are unable to determine a more appropriate industry entry point.

3.1.4 More about Entry Points

The financial concepts and their relationships in an industry folder are further divided to give preparers greater flexibility to prepare and publish instance documents. Within each industry group preparers have the following four options:

- Face of the financial statements and disclosures—all content (most useful to preparers)
- Face of the financial statements only—all content
- Face of the financial statements and disclosures—element labels only, without element definitions or authoritative references
- Face of the financial statements only—element labels only, without element definitions or authoritative references

Figure 11 presents the options (by number), the related file name, and their content.

Figure 11 Four Entry Points per Industry

Option	File Name	Face of the Financial Statements	Element Labels	Element Definitions and Authoritative References	Disclosures
1.	us-gaap-{industry}-stm-dis-all	X	X	X	X
2.	us-gaap-{industry}-stm-all	X	X	X	
3.	us-gaap-{industry}-stm-dis	X	X		X
4.	us-gaap-{industry}-stm	X	X		

Rule of Thumb: Use the industry entry point that includes all of the content for that industry when creating the company's extension taxonomy. The file names of these entry points contain the phrase "stm-dis-all". 

The other entry points are for users who are mainly interested in face of the financial statement data or text of the notes. The reduced content of these entry points significantly decreases the time required to open the files. However, these other entry points are not recommended for companies creating their extension taxonomy and instance documents.

3.1.5 Selecting the Industry and Reporting for Conglomerates

Rule: Select the industry entry point that most closely reflects the content and organization of the financial statements. 

Selecting an industry entry point that most closely reflects the content and organization of the financial statements will reduce the work required to create the company's extension taxonomy. While selecting the appropriate industry entry point will be easy for most companies, preparers can find additional help in [Appendix B](#), which shows SIC codes and industry entry points.

Rule: For entities operating in more than one industry, use the following process: 

- **Industries organize elements into relationships that are common or typical for that particular industry. Choose the industry entry point that most closely reflects the content and organization of the financial statements.**
- **Use that entry point as a base (for example, if the company is primarily a broker-dealer firm that has an insurance operation, first select the Brokers and Dealers entry point).**
- **Use concepts found in the statements or disclosures of other industries (for example, from the Insurance entry point), as needed.**

- **Create new elements if necessary elements cannot be found. Every industry entry point contains all elements, even if they are not all used in statements or disclosures in that entry point.**

3.1.6 Non-GAAP Taxonomies

The Document and Entity Information (DEI) taxonomy contains tags for capturing details about the entity to which the instance document applies and the nature of the financial information being reported. Entity information may include contact names and addresses, legal entity names, websites, stock exchanges where the entity's securities are traded, SIC codes, and so forth. Document information might include the name of the document represented in the instance document (for example, Annual Report, Earnings Release), the type of document (for example, Form 10-K or Form 8-K), date, period covered (for example, Fiscal Year ended December 31, 2007), and other information preparers might make available with the XBRL instance document.

The DEI taxonomy is itself broken into smaller taxonomies, each of which contains only a single kind of information: country codes, currency codes, exchange codes, state and province codes, Standard Industrial Classification (SIC), codes and North American Industry Classification System (NAICS) codes. An extension taxonomy can refer to these other taxonomies in addition to the US GAAP Taxonomy.

The XBRL US GAAP Taxonomies v1.0 contains a number of other taxonomies, including Accountant's Report on Financial Statements, Management's Report on Internal Control Over Financial Reporting, Officer Certification Required by SEC Exchange Act Rule 13a-14(a) or Rule 15d-14(a), and Management's Discussion and Analysis. However, the focus of this guide is the XBRL US GAAP Taxonomy.

3.1.7 Anatomy of an Element

Each financial reporting concept is represented by an element in the taxonomy. Elements represent financial reporting concepts that are numeric, textual (strings of text, sentences or groups of sentences), and date-oriented. Ideally, financial statement preparers will consistently use the same elements for similar financial reporting concepts in instance documents.

Figure 12 shows the two contributors to the meaning of an element: [attributes](#) and relationships. Attributes are the properties that provide the defining characteristics of a stand-alone, independent element. Relationships are the "external" characteristics that further define the element in terms of the other elements in the taxonomy.

Figure 12 Anatomy of an Element

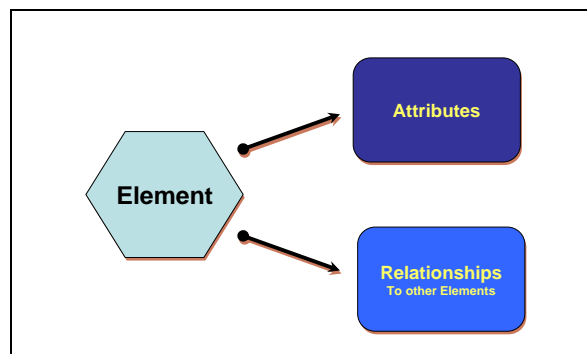
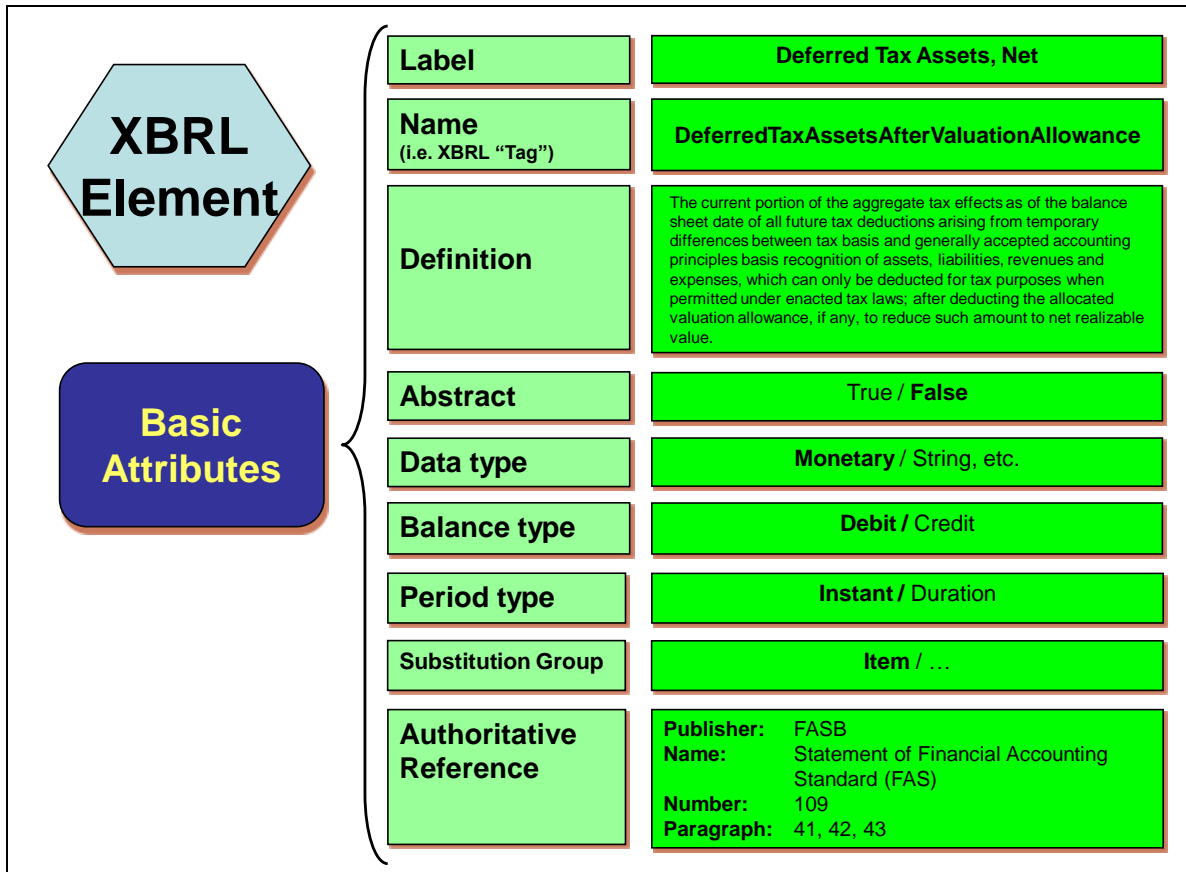

Figure 13 shows the attributes of an element.

Figure 13 Element Attributes



Label

Each label provides a succinct description of the element, similar to a line item caption in a financial statement. The XBRL US GAAP Taxonomy contains a label for every element in the taxonomy; however, in the extension taxonomy preparers may provide new labels if desired to match the words used in the financial statements. Elements may have more than one [label type](#). Every element in the XBRL US GAAP Taxonomy has a *standard* label. One element may use different labels within a single set of financial statements. For example:

- Accounts receivable may have the label "Accounts receivable" on the balance sheet but may be called "Total accounts receivable" in the notes where a detailed breakdown is provided.
- Treasury stock is conventionally shown as a negative number on the balance sheet, but the same amount may be shown as a positive number in an Equity Note.
- Figure 14 illustrates a roll-forward analysis (the activity during the period that reconciles the beginning and ending balance of an asset, liability or equity item). In a roll-forward, the same financial concept appears with both a period beginning and ending balance, along with other elements representing the amounts that contribute to the increase or decrease during the period. This demonstrates a need for three separate labels for the same element (that is, the standard label, a period start label, and a period end label).

Figure 14 Multiple Labels with a Roll-Forward

Balance Sheet Disclosure:		2013
...		
Property, plant, and equipment		1,618
...		
Disclosure in notes:		
Property, plant, and equipment, beginning balance		\$ 1,522
Additions		277
Disposals		(24)
Depreciation		(139)
Other		(18)
Property, plant, and equipment, ending balance		\$ 1,618

XBRL gives preparers the ability to create these and other labels that they need and to specify which label to use in different places in the face of the financial statements and notes. Figure 15 shows the different types of labels available. Extensions may change these labels for any element that exists in the XBRL US GAAP Taxonomy. [Negating labels](#) are described further in [Section 6.3](#).

Figure 15 Label Types, with Examples of Each

Label Type	Treasury Stock Value	Increase/Decrease in Prepaid Expense
Standard label	Treasury Stock, Value	Increase (Decrease) in Prepaid Expense
Total label	Treasury Stock, Value, Total	Increase (Decrease) in Prepaid Expense, Total
Period start label	Treasury Stock, Value, Beginning Balance	
Period end label	Treasury Stock, Value, Ending Balance	
Negating label	(Less) Treasury Stock, Value	(Increase) Decrease in Prepaid Expense
Negating total label	(Less) Treasury Stock, Value, Total	(Increase) Decrease in Prepaid Expense, Total
Negating period start label	(Less) Treasury Stock, Value, Beginning Balance	
Negating period end label	(Less) Treasury Stock, Value, Ending Balance	

XBRL permits labels in multiple languages, but the XBRL US GAAP Taxonomy always uses the language "English (United States)", abbreviated "en-US".

Name

The element name uniquely identifies a particular element—much as a Vehicle Identification Number (VIN) uniquely identifies a specific automobile—and provides the basis for comparability among different instance documents.

In the XBRL US GAAP Taxonomy, the element name is derived from an element's standard label simply as a matter of convention. However, the element name could theoretically be any text, so long as that sequence is unique. In addition, to maintain consistency among different major versions of the taxonomy, the element name for a particular element never changes, even if the label upon which it was originally based changes.

An extension does not, and cannot, change the name of an element that exists in the XBRL US GAAP Taxonomy. Having a unique, unchanging identifier facilitates comparison of the same element used in different instance documents even if the documents have extensions that give different labels to the same element.

Definition

The element definition identifies the unique characteristics and meaning of the financial reporting concept that the element represents.

The main objectives of the element definition are to enable preparers to decide whether it adequately represents the financial concept disclosed in the financial statements and to distinguish that element from other similar elements.

Figure 16 Element Definition Example

Attribute	Example
Name	AccountsPayableAndAccruedLiabilities
Standard label	Accounts Payable and Accrued Liabilities
Definition	Carrying value as of the balance sheet date of obligations incurred and payable, pertaining to goods and services received from vendors; and for costs that are statutory in nature, are incurred in connection with contractual obligations, or accumulate over time and for which invoices have not yet been received or will not be rendered. Examples include taxes, interest, rent, salaries and benefits, and utilities. For classified balance sheets, used to reflect the current portion of the liabilities (due within one year or within the normal operating cycle if longer); for unclassified balance sheets, used to reflect the total liabilities (regardless of due date).

When deciding whether an element is the most appropriate for the particular concept in the financial statements, **the definition is the single most important piece of information preparers should consider**, but it should not be the only information considered.

An extension must not, and in most XBRL-enabled software, *cannot*, change the definition of an element that exists in the XBRL US GAAP Taxonomy.

Abstract

Abstract elements cannot be used to tag data in an instance document. Instead, their purpose is to nest and order other elements in the taxonomy for presentation.

Figure 17 shows that “Current assets:” would be represented by an abstract element. As a header, it has no associated data to be tagged and thus would never appear in an instance document. Abstract elements are useful in providing titles and headers that appear when rendering an instance document in published financial statements.

Figure 17 Abstract Element as Heading

→ Current assets:		
Cash and cash equivalents	\$ 663	\$ 590
Marketable debt and equity securities	6,283	4,632
Accounts receivable (Note 4)	24,138	23,211
Inventories (Note 5)	20,152	21,825
Current deferred tax assets (Note 13)	503	449
Other current assets	908	333
Total current assets	52,647	51,040

The abstract attribute can be set to true (the element *is* an abstract element) or false (the element *is not* an abstract element). In the XBRL US GAAP Taxonomy, the labels for abstract elements are appended with the notation [Abstract]. Abstract elements have no definition and no references.

An extension cannot change whether an element in the XBRL US GAAP Taxonomy is abstract.

Data Type

The data type attribute defines what type of data is expected for an element. For example, the amount reported on ABC Company and Subsidiaries’ 2013 Consolidated Balance Sheet for Inventories of \$20,152 would correspond to an element with a “monetary” data type.

Figure 18 Data Types Most Frequently Occurring

Data Type	Description
Monetary	This data type is used for financial concepts expressed in units of currency. (Note: The specific currency is specified separately for every fact in each instance document.)
Shares	This type is used for financial concepts expressed as a number of shares of stock (common or preferred) or units of interest.
Per Share	This data type is used for financial concepts expressed per share.
Text Block	A text block is used to tag a section of disclosure and narrative, or complete tables. It keeps all the text and numbers together in order to maintain the integrity of the explanation. Text blocks can contain extra spaces for indentation, paragraphs, and line breaks, but do not rely on users' software to use that for display. Text blocks never under any circumstances preserve column layouts, page breaks, lines, typeface, colors or graphics. A narrative or table tagged as a text block can only be read by software as a whole. Therefore, it is often desirable to individually tag significant facts within the text block. Each disclosure and table in the XBRL US GAAP Taxonomy has at least one element with the text block data type for tagging the entire disclosure or table.
String	This data type is used for elements that will contain unformatted text such as individual words or phrases and may be mixed with numbers.
Date String	This data type is used when the format of the date does not conform to one of the fixed format data types or is a range of dates.
Duration String	This data type is used to express a period of time, such as three months or one fiscal quarter, when the format used to express the period is flexible.
Period String	This data type is used when a period has specific beginning and ending dates but the format for the dates is flexible, as when it is a range of possible periods.
Decimal	This data type is used to represent non-currency decimal numbers, such as a number of employees, when there is not a specific, but infrequently used type such as "volume" or "boe" (barrels of oil equivalent).
Pure	This data type represents numbers that are a ratio of one unit of measure to the same unit (for example, dollars divided by dollars is a pure number).
Percent	This data type is used for pure numbers conventionally presented as percentages. It is always a decimal ratio (such as ".97"), <i>not</i> in hundredths (such as "97%").
URL	This data type is used for elements that will contain a Universal Resource Locator (URL). One of the most common examples of a URL is a web address (such as www.xbrl.us).
Date/Time	This data type is used for a fact that is expressed as a date, time, or a combination of date and time. Dates must be expressed in the format YYYY-MM-DD; times in the format YYYY-MM-DD:HH:MM:SS.
Year/Month	This data type is used for expressing a year and month in the format YYYY-MM.
Year	This data type is used for expressing a year in the format YYYY.

An extension cannot change the data type of an element that exists in the XBRL US GAAP Taxonomy.

Balance Type

The [balance](#) type attribute indicates when a monetary element has an expected accounting balance (that is, debit or credit). Balance attributes are essential to permit software programs to interpret the [facts](#) in an instance document consistently, and particularly the meaning of positive and negative numbers. The balance attribute is assigned strictly based on its normal presentation in the balance sheet or income statement; it is *not* assigned to an element based on where it *might* be presented in a financial statement.

Most monetary elements have balance types. For example, "Inventories, Net" has a balance type of debit.

The balance attribute impacts the [calculation relationships](#) allowed; for example, an element with a credit balance cannot be calculated by adding an element with a credit balance to an element with a debit balance; the debit balance must be subtracted. A few of the elements on the cash flow statement, such as "Adjustments to Reconcile to Income (Loss) from Continuing Operations", have no balance attribute, because they represent the netting of various debit and credit balance elements.

An extension cannot change the balance type of an element that exists in the XBRL US GAAP Taxonomy.

Period Type

The period type attribute must be either “instant” or “duration”. An element with a period type of “instant” identifies elements whose values are only measurable at a point in time (such as assets, liabilities, outstanding shares); “duration” is used for all other elements, including all string (text) and block text data types.

An extension cannot change the period type of an element that exists in the XBRL US GAAP Taxonomy.

Substitution Group

The substitution group attribute will always be “item” unless preparers are creating a new table or [axis](#) as described in [Section 6, Creating Extensions](#). The substitution group indicates whether the element is an ordinary “item” or is a special element defining a [table](#).

An extension cannot change the substitution group of an element that exists in the XBRL US GAAP Taxonomy.

Authoritative Reference

Authoritative references are used to provide further information about an element and help distinguish one element from another. Figure 19 shows the sources for authoritative references used in the XBRL US GAAP Taxonomy.

Figure 19 Authoritative Reference Sources

Publisher	Name
AICPA	Accounting Principles Board Opinions (APB)
AICPA	Accounting Research Bulletin (ARB)
AICPA	Audit and Accounting Guide (AAG)
AICPA	Practice Bulletin (PB)
AICPA	Statement of Position (SOP)
AICPA	Technical Practice Aid (TPA)
FASB	Derivatives Implementation Group (DIG)
FASB	Emerging Issues Task Force (EITF)
FASB	FASB Interpretation (FIN)
FASB	FASB Staff Position (FSP)
FASB	FASB Technical Bulletin (FTB)
FASB	Implementation Guide (Q and A)
FASB	Statement of Financial Accounting Concepts (CON)
FASB	Statement of Financial Accounting Standard (FAS)
OTS	Federal Regulation (FR)
SEC	Financial Reporting Release (FRR)
SEC	Regulation S-K (SK)
SEC	Regulation S-X (SX)
SEC	Rule 15c3
SEC	Staff Accounting Bulletin (SAB)
SEC	Industry Guide

An example of an authoritative reference for the element “Assets” would include:

Publisher: FASB
 Name: Statement of Financial Accounting Concepts (CON)
 Number: 6
 Paragraph: 25

The authoritative references in the XBRL US GAAP Taxonomy are citations only, displaying the publisher, name, and number of the source, and the relevant article, chapter, paragraph, and subparagraph of the source, not the text of the reference itself. The list cites guidance that is neither authoritative under Statement of Auditing Standards No. 69, *The Meaning of Presenting Fairly in Conformity With Generally Accepted Accounting Principles*, nor under Auditing Standard No. 6, *Evaluating Consistency of Financial Statements*.

Authoritative references serve only to assist preparers in identifying the appropriateness of using an element to tag a financial statement concept, and specifically to help them distinguish one element from another. The XBRL US GAAP Taxonomy does not include every, or even most, of the authoritative references for a given element. Typically, it contains one or two references deemed most useful for helping preparers determine the appropriate element to represent a financial reporting concept. References typically are disclosure requirements or definitional information associated with the financial concept and not the recognition or measurement guidance for that concept.

The existence of an authoritative reference does not indicate that the element is a disclosure requirement for the company, so preparers should not use the authoritative references as a guide or checklist for US GAAP or SEC reporting and disclosure requirements.

An extension cannot change the references of an element that exists in the XBRL US GAAP Taxonomy.

3.1.8 Relationships

Taxonomies include relationships between elements. Figure 20 shows the three most important types of relationships. The basic model for any relationship is the parent-child relationship. Parent elements are superior to their children elements, which almost all software represents visually by indenting children below the parent, as in a basic outline structure. Child elements of the same parent are called siblings. Figure 20 shows examples of this kind of indentation based on parent-child relationships.

Figure 20 Relationships

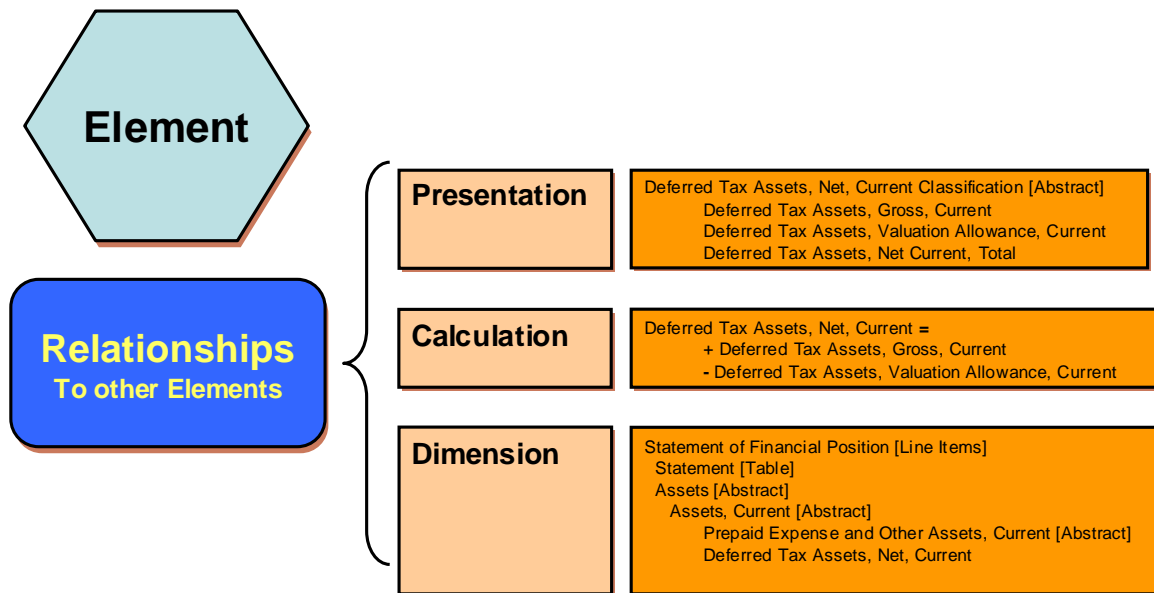

Each set of relationships is maintained in separate "[relationship files](#)".

Presentation Relationships

Presentation relationships in the XBRL US GAAP Taxonomy arrange elements in the order that they typically appear in published financial statements. Parent elements are the header element for their children and are predominantly abstract elements. Figure 21 shows the taxonomy presentation structure for the Current Assets portion of ABC Company and Subsidiaries' balance sheet, as they might organize it in their extension taxonomy. Elements such as "Inventory, Net" and "Other Assets, Current" are children of the parent "Assets, Current [Abstract]". "Assets, Current, Total" appears last.

Figure 21 ABC Company and Subsidiaries Current Assets, Presentation Relationships

Assets (In thousands)		
Assets, Current [Abstract]		Parent
Cash, Cash Equivalents, and Short-term Investments		Child
Marketable Securities, Current		Child
Receivables, Net, Current		Child
Inventory, Net		Child
Deferred Tax Assets, Net, Current		Child
Other Assets, Current		Child
Assets, Current, Total		Child

(Siblings)

The order and indentation of the elements in presentation relationships achieves several purposes:

1. It arranges the elements similar to a published financial statement, to facilitate locating the elements.
2. It groups similar elements. For example, the "Earnings Per Share [Abstract]" element appears in the Statement of Income with children representing basic and diluted earnings per share, dividends per share, number of shares, and so forth. "Parenthetical" disclosures to a financial statement line item appear as presentation children.
3. It indicates levels of detail in Disclosures. For example, the "Debt Disclosure [Text Block]" element is for tagging all of the text in a note together. The text block then has many presentation descendants with elements for tagging more detail within the note, such as "Short-term Debt [Text Block]" and "Line of Credit Facility [Table]".

Although an extension matches the presentation of elements to the ordering and grouping in published financial statements, it cannot duplicate formatting, layout, pagination, color, fonts, and so forth.

Calculation Relationships

Calculation relationships portray the mathematical relationship between elements—that is, how a series of elements sum to another element in the taxonomy. The parent-child relationship is called "summation-item" in the calculation relationship.

Most XBRL-enabled software shows calculation relationships with the summation element (the parent) first and the children below. This is the opposite of how these elements are displayed in presentation relationships. Also, the calculation relationships file has no abstract headers, and only the [standard labels](#) of elements are shown.

Figure 22 Presentation vs. Calculation Relationships for ABC Company and Subsidiaries

Presentation Relationships		Calculation Relationships	
Assets, Current [Abstract]	Parent	Assets, Current	Parent (Summation)
Cash, Cash Equivalents, and Short-term Investments	Child	Cash, Cash Equivalents, and Short-term Investments	Child (Item)
Marketable Securities, Current	Child	Marketable Securities, Current	Child (Item)
Receivables, Net	Child	Receivable, Net	Child (Item)
Inventories, Net	Child	Inventories, Net	Child (Item)
Deferred Tax Assets, Net, Current	Child	Deferred Tax Assets, Net, Current	Child (Item)
Other Assets, Current	Child	Other Assets, Current	Child (Item)
Assets, Current, Total	Child		

XBRL-enabled software uses calculation relationships to analyze the [facts](#) in an instance document for inconsistencies between calculated totals and reported totals. It does *not* insert *new* facts based on amounts provided in the instance document.

Rule of Thumb: Tag all of the subtotals and totals that appear in the financial statements, or XBRL software will assume that those numbers do not exist and flag calculation inconsistencies. 

XBRL calculations do not work in the same manner as spreadsheet software, which evaluates all the formulas, produces new values, and continues evaluating all the formulas. XBRL-enabled software checks each fact just once against each set of calculation children, and reports any inconsistency it finds. Figure 23 shows the impact: "Assets, Noncurrent" is not reported, so the software calculates "Assets" based only on the fact that it has ("Assets, Current" is 20,000).

Figure 23 Example of an Inconsistency in an Instance Document

Calculation Relations	Instance Contains	Calculated	Result
Assets	100,000	20,000	Inconsistent
+ Assets, Current	20,000	20,000	
+ Assets, Noncurrent			
+ Property, Plant and Equipment, Net	50,000	50,000	
+ Goodwill	30,000	30,000	

Usually, an inconsistency warning will include the details of the underlying calculation.

Figure 24 is the same as Figure 23 except that there is no "Assets" value reported. This illustrates that if an amount does not appear in the instance, then it is not calculated. Therefore, the absence of a reported amount will not be flagged as inconsistent.

Figure 24 No Reported Fact, No Inconsistency

Calculation Relations	Instance Contains	Calculated	Result
Assets			Consistent
+ Assets, Current	20,000	20,000	
+ Assets, Noncurrent			
+ Property, Plant and Equipment, Net	50,000	50,000	
+ Goodwill	30,000	30,000	

Figure 25 is the same as Figure 23 except that the intermediate element "Assets, Current" no longer appears in the calculation relationships. This illustrates how a preparer can arrange calculation relationships in an extension so that an instance document will not be inconsistent.

Figure 25 Extension with Calculation Relationships Eliminating Inconsistency

Calculation Relations	Instance Contains	Calculated	Result
Assets	100,000	100,000	Consistent
+ Assets, Current	20,000	20,000	
+ Property, Plant and Equipment, Net	50,000	50,000	
+ Goodwill	30,000	30,000	

Dimension Relationships

Dimension relationships capture detailed information about the horizontal and vertical axes of a table in a note to the financial statements. Figure 26 shows an example of a table, first in the form it takes in a financial statement disclosure, then in its XBRL equivalent. The children of "Deferred Revenue Arrangement [Line Items]" are the same as the presentation relationships, and the calculation summation of Deferred Revenue from its current and noncurrent components is in the calculation relationships.

Figure 26 Dimensions Example (Dimensional Relationships)

Original:

Deferred Revenue (in thousands)	Layaway Sales	Subscriptions	Total
Deferred Revenue, Current	80	20	100
Deferred Revenue, Noncurrent	40	-	40
Total			140

XBRL representation with Line Items on the vertical axis:

	Layaway Sale [Member]	Subscription Arrangement [Member]	Deferred Revenue Arrangement Type [Domain]
Deferred Revenue Arrangement [Line Items]			
Deferred Revenue [Abstract]			
Deferred Revenue, Current	80,000	20,000	100,000
Deferred Revenue, Noncurrent	40,000		40,000
Deferred Revenue			140,000

The original layout in the financial statement might as easily have been that shown in Figure 27, but the XBRL equivalent table would be identical to the previous example, with identical data. Columns and rows can be exchanged to provide a different, though equally legitimate, presentation. Being able to adjust the table into a familiar arrangement makes it easier for preparers to inspect the data to verify that it matches the original report.

Figure 27 Dimensions Example, Different Original (Dimensional Relationships)

Original:

Deferred Revenue (in thousands)	Current	Noncurrent	Total
Layaway Sales	20	-	
Subscriptions	80	40	
Total	100	40	140

XBRL representation with Line Items rotated to the horizontal axis:

	Deferred Revenue, Current	Deferred Revenue, Noncurrent	Deferred Revenue	Deferred Revenue [Abstract]	Deferred Revenue Arrangement [Line Items]
Deferred Revenue Arrangement Type [Domain]	100,000	40,000	140,000		
Layaway Sale [Member]	80,000	40,000			
Subscription Arrangement [Member]	20,000				

Any fact appearing in a row or column labeled in Figure 26 with a [Domain], such as "Deferred Revenue Arrangement Type [Domain]", is automatically equivalent to the same line item in the balance sheet or income statement. This feature of dimensions provides consistency between the statements and the details provided in notes and schedules.

[Section 5, Using Tables](#), explains in detail how dimensional relationships and special elements form the axes: [table elements](#), [axes](#), [domains](#), [domain members](#), and [line item](#) elements.

3.1.9 Mapping Financial Statement Line Items to Elements

All parts of the XBRL US GAAP Taxonomy described so far are used in the financial statement mapping process, but it is the elements, their definitions and references that take precedence over any relationships. The presentation relationships in the XBRL US GAAP Taxonomy are designed to assist a user in finding the appropriate elements in the taxonomy, with each industry's elements organized in a hierarchy similar, though not identical to, common reporting practices in that industry. Since the XBRL US GAAP Taxonomy presentation relationships are generic and draw a compromise between variations found in practice, an element may not appear where preparers expect, may not appear in a

particular industry taxonomy, or may not exist in the taxonomy at all. For example, there are eleven possible combinations of “depreciation”, “amortization”, “impairment”, and “depletion”, but not all eleven are included as distinct elements in the taxonomy. Accordingly, preparers will be required to extend the taxonomy to add elements they are unable to find.

It can be difficult to decide between selecting an element from the taxonomy and creating a new element, but it is important that preparers only use an existing taxonomy element if it accurately represents the financial reporting concept being reported. At the same time, if an existing element appropriately represents the financial reporting concept, it should be used, because creating a new element that is redundant with what already exists in the taxonomy reduces the usefulness of the financial information in XBRL.

Preparers should also remember that an element represents a financial reporting concept whose attributes cannot change (specifically, the definition and references). However, the label that appears in the extension taxonomy, and therefore any rendering of that instance document, can be changed to match the financial statements without affecting the comparability and usefulness of the underlying tagged information.

Rule: Search all elements in the taxonomy, even those not in the statements of the chosen industry taxonomy, before creating a new element in the extension taxonomy.



To find the most appropriate element in the taxonomy that matches the financial statement, consider all of the attributes and relationships of an element. Begin with the element’s standard label, which will be listed in the presentation view of the taxonomy in most XBRL software. Each element has its own unique standard label that is a commonly recognizable name for the underlying financial concept. These labels are organized by the type of statement and disclosure in a hierarchical structure to assist the user in finding the appropriate element. XBRL software always has some capabilities to search through the taxonomy to find the appropriate element.

However, the standard label alone does not provide enough definitive information to select an element for tagging a financial concept. Element labels can be worded in many different ways but still mean the same thing. They should be interpreted by the substantive meaning provided in the element’s definition and other attributes.

Rule: When a more specific element does not exist, use the element that has the attributes and relationships that are consistent with the financial reporting concept that is to be tagged.



First, consider the following attributes of an element when determining whether to use that element to tag a financial reporting concept.

Element definition

The definition is an element’s most important attribute and must be consistent with the financial concept reported. Definitions cannot be changed.

Rule: Do not use an element based solely on its label. Use an element that has a definition that is consistent with the financial concept being represented.



An element should be interpreted by the substantive meaning provided in its definition; decisions on whether it is appropriate must not be based solely on the label. The standard label conveys meaning through:

- Adjectives (“Net”, “Gross”; “Basic”, “Diluted”)
- Conjunctions (“Interest, Dividends and Other Income” versus “Interest and Dividends”)
- Phrases (“Proceeds from (Payments to)”; “Increase (Decrease) in”)

Although these conventions are applied with a high degree of consistency in the XBRL US GAAP Taxonomy, noun phrases naturally have a variety of synonyms. The XBRL US GAAP Taxonomy settles on a single noun phrase to use consistently. For example, “Fixed Assets” may be synonymous with “Property, Plant and Equipment”, but “Fixed Assets, Gross” is a different financial concept from

“Property, Plant and Equipment, Net”. For a list of some synonyms used and not used, refer to Figure 128, “ Spelling Used in Preference to Alternative Spellings”, in [Appendix D](#).

In the extension, preparers can give a new standard label to an element to aid their selection, but others using the extension might not understand the label in the same way. In short, the standard label offers a good hint at what concept the element represents, but it is secondary to the element definition and references.

As important as they are, all definitions have limitations, so preparers should not discard an element simply due to minor, nonmaterial differences with the definition. However, they should never use an element whose definition *excludes* financial reporting concepts they wish to represent. For example, the definition for “Other Restructuring Costs” states that it “excludes costs associated with the retirement of a long-lived asset and severance costs associated with established compensation plans.”

Determining whether a definition is consistent with the financial concept may require judgment, and other attributes of the element must be considered.

Abstract

Rule: Do not map an abstract element to a line item or disclosure; map it only to headings or subheadings.



Every abstract element in the XBRL US GAAP Taxonomy has a word or phrase in brackets at the end of its standard label. “[Abstract]” appears at the end of many abstract elements. Other phrases include:

- “[Roll Forward]” to group a beginning balance, other elements, and an ending balance
- “[Line Items]” to group together elements belonging in a [table](#)

The convention of appending standard labels with a bracketed phrase is a feature of the XBRL US GAAP Taxonomy. Abstract elements are used only to create headings with no data items. They can never be used to tag data in an instance document.

Data type

Data types are explained in Figure 18.

Rule: Use an element that has the most specific data type attribute that is consistent with the financial concept reported.



For example, if a preparer is tagging only a dollar amount and finds some potential matches that are monetary and others that are strings or text blocks, the monetary elements must be used. Similarly, “per share” dollar amounts must be tagged with “per share” elements, and so forth.

Figure 28 illustrates how searching for a “Debt Instrument” could yield several matching elements with different data types. Tagging the fee amount shown as “\$40,000” using the string element “Debt Instrument, Fee” would be inappropriate when the more specific monetary element “Debt Instrument, Fee Amount” exists.

Figure 28 Data Type Attribute Examples

Element Standard Label	Data Type	Example Values												
Debt Instrument, Call Date, Earliest	date item	"2008-11-15"												
Debt Instrument, Fee	String	"The fee is composed of a 4% flat fee and a commitment fee of 1% on unborrowed portions"												
Debt Instrument, Fee Amount	Monetary	40000												
Debt Instrument, Interest Rate, Effective Percentage	Percent	"0.0325"; "0.1025"												
Debt Instrument, Issuance Date	date string item	"2007-11-11"; "Before 1999"; "After 2008-11-11"												
Schedule of Debt Instruments [Text Block]	text block	<table border="1"> <thead> <tr> <th>Date</th> <th>Amount (in 000s)</th> <th>Description</th> </tr> </thead> <tbody> <tr> <td>2005-12-14</td> <td>\$ 350</td> <td>Credit Agreement of senior secured term and revolving credit facilities</td> </tr> <tr> <td>2006-12-15</td> <td>200</td> <td>Tranche A Term Loans</td> </tr> <tr> <td>2006-12-15</td> <td>150</td> <td>Revolving Credit Commitment</td> </tr> </tbody> </table>	Date	Amount (in 000s)	Description	2005-12-14	\$ 350	Credit Agreement of senior secured term and revolving credit facilities	2006-12-15	200	Tranche A Term Loans	2006-12-15	150	Revolving Credit Commitment
Date	Amount (in 000s)	Description												
2005-12-14	\$ 350	Credit Agreement of senior secured term and revolving credit facilities												
2006-12-15	200	Tranche A Term Loans												
2006-12-15	150	Revolving Credit Commitment												
Debt Instrument, Face Amount	Monetary	"350000"; "200000"; "150000"												

The value of a string or text block element may *contain* dollar or other amounts that occur in a phrase or sentence. Text blocks are intended only for entire disclosures, encompassing section titles, bullet lists, paragraphs, sections, table captions, or tables.

A figure such as "\$150" may appear both inside of a text block as well as being tagged separately with a monetary element.

Period type

An element with a period type of "instant" has values that are only measurable at a point in time; "duration" is used for all other elements, including textual information. Most elements in the taxonomy have the "duration" period type.

Rule: Use an element that has a period type that matches the financial concept reported.



Adhering to the general principle of one element per financial concept, elements in the XBRL US GAAP Taxonomy are never identified as being a beginning or ending period amount. The same element can represent both a beginning and ending balance, because the underlying financial concept is the same. The differentiating factor is the point in time, which is identified in the instance document and not the taxonomy. For example, in the Property, Plant and Equipment roll-forward (Figure 14), the "Property, Plant and Equipment, Net" element is used twice, with facts in an instance document indicating the date of the reported amount.

Authoritative references

In the XBRL US GAAP Taxonomy, authoritative references are included to assist preparers in determining the appropriateness of using a particular element to tag a specific financial concept. A single reference may be included in multiple elements in the taxonomy.

Preparers should exercise judgment when evaluating whether references support the use of an element for a specific financial reporting concept. References offer additional information that, used in conjunction with other attributes, can assist preparers in determining whether an element is appropriate, but they should not be the primary evidence that an element matches a reported financial concept.

Second, consider relationships when determining whether to use an element.

Relationships

Presentation, calculation, and dimension relationships provide additional information that may be helpful in selecting an appropriate element, but preparers must not rely on relationships as the

primary source of information about an element. Relationships can indicate the original intent of an element (for example, the location in the taxonomy's hierarchy and calculations provide clues as to the meaning of an element), but not all of the potential relationships for an element are captured in the XBRL US GAAP Taxonomy.

An element may appear in the taxonomy in calculations that differ from the calculations that are reflected in the financial statements. For example, in Figure 23, "Goodwill" is a descendant but not a child of "Assets"; in Figure 25 "Goodwill" is a child of "Assets". Just because the calculations differ, it does not mean that the element is not the appropriate financial reporting concept.

Also, in an extension, the preparer is able to rearrange all relationships, but others using the extension may not understand those relationships in the same way.

Rule of Thumb: Do not use relationships as the primary source of information about the meaning of an element.



Some attributes of an element are irrelevant to the decision.

Element name

Element names are not definitional and not meaningful; they are merely a sequence of characters used to uniquely identify an element. In the XBRL US GAAP Taxonomy, there is a fixed relationship between the standard label ("Property, Plant and Equipment, Net") and the element name (PropertyPlantAndEquipmentNet), but the element name should not be used to determine whether the element is appropriate to represent a financial concept.

Rule: Do not use the element name as a source of information about the element.



Balance type

Balance types (debit or credit) are assigned to elements in the XBRL US GAAP Taxonomy from the perspective of the income statement and balance sheet. This perspective may be inconsistent with the presentation of the element in the financial statements. For example, a financial concept in the cash flow statement may be represented by an element that was assigned a balance type based on the income statement. As a result, the balance type may be different from preparers' expectations. A different balance type must not influence preparers in deciding whether the element is appropriate for tagging a financial concept, and they should not create a new element if an element in the taxonomy is consistent with the financial concept reported in all respects except the balance type.

Rule: Use an element even if the balance type is not the balance type expected.



Rule: Use a negative number in an instance document for an element that has a balance type that is inconsistent with the reporting concept in the source document.



Summary

The attributes and relationships associated with an element are useful in determining whether an element maps to a specific financial concept. One or more attributes and relationships may clearly exclude an element from consideration; if not, professional judgment will be needed to weigh the other sources of definitional information and determine the most appropriate element to use.

Rule: Search for similar elements in the taxonomy that may more clearly match the financial concept reported when there is uncertainty about whether an element is a good match.



If the only existing elements found in the published taxonomy are too general, then the preparer must create a new element. However, it should be noted that creating a new element reduces the extension taxonomy's reusability.

4 USING TAXONOMY CALCULATIONS

Calculation relationships specify which elements are totals and which elements are combined to make totals. Adding and subtracting the values in the instance document and comparing that calculated total to the amount tagged as the total in the instance document, XBRL-enabled software can notify the user when inconsistencies exist between the two.

When reading the taxonomy calculation examples in this section, preparers should note the following:

- Taxonomies themselves do not contain a company's data. Amounts appear in examples only to assist in understanding the effect of decisions made at the taxonomy level. The data exist *only* in the XBRL instance document, as discussed in Section 7, *Creating Instance Documents*.
- The exhibits in this section are presented using either the presentation or calculation relationships or, on occasion, both. Each example is labeled as to which relationships are being shown.

Calculation relationships for elements in the taxonomy can benefit preparers by verifying whether the values that participate in a financial statement calculation have been tagged correctly in the instance document. For example, in Figure 29, the Current Assets, Total as of December 31, 2013, is \$52,647. If the calculated value of "Current Assets, Total" as defined in the calculation relationships (663 + 6,283 + 24,138 + 20,152 + 503 + 908) produces an amount different from the tagged value of \$52,647, software should notify the preparer of this inconsistency.

Figure 29 Calculation Example (shown in Presentation Relationships)

**ABC Company and Subsidiaries
Consolidated Balance Sheets**

	December 31, 2013	December 31, 2012
ASSETS		
Current assets:		
Cash and cash equivalents	\$ 663	\$ 590
Marketable debt and equity securities	6,283	4,632
Accounts receivable (Note 4)	24,138	23,211
Inventories (Note 5)	20,152	21,825
Current deferred tax assets (Note 13)	503	449
Other current assets	908	333
Current Assets, Total	52,647	51,040

Siblings {

This functionality provides preparers with a control feature for monetary and other numeric types of data. Calculations can also benefit users of the instance document by helping to define the relationships of monetary data type elements to other elements.

4.1.1 What Calculations Do and Do Not Do

Calculation relationships *do*:

- Specify which elements are totals and which elements are added together to make a total.
- Allow comparison of the calculated total to the tagged total and, when applicable, signal inconsistencies.
- Provide multiple calculation relationships for the same element.

However, calculation relationships also have limitations. They:

- Do not create new information; they only use summation relationships between numeric elements to detect inconsistencies. That is, a total is not created in the instance document even when the items that sum to the total are tagged.
- Detect inconsistencies *only* among values that are of the same period type (instant or duration) and therefore do not detect inconsistencies in a balance roll-forward.
- Check every fact for consistency with its calculation children and sometimes report inconsistencies where facts are unreported. For example, in a PP&E gross-to-net calculation, the

net amount is reported on the face of the financial statements and accumulated depreciation is reported parenthetically, but the gross is not shown explicitly. In other words, net PP&E and accumulated depreciation are tagged, but gross PP&E is not tagged. If a gross-to-net calculation were included in the calculation relationships, it would flag an inconsistency, but no corrective action by the preparer would be required.

- Check only tagged values and do not provide values for missing elements such as subtotals and totals. If the value is not tagged, there is nothing to include in the consistency check.

4.2 Rules that Define How Calculations Work

Calculation relationships work according to a set of rules.

4.2.1 The Population of Facts

When preparers tag a value for an element to create a [fact](#), that fact appears everywhere that element appears in the calculation relationships of the taxonomy. For example, when an amount for Net Income on the Income Statement is tagged, that number will also appear for that element on the Cash Flow Statement, the Statement of Stockholders' Equity, and anywhere else it appears in the taxonomy.

This makes sense based on the way XBRL works, logically and technically. Logically, each element is defined as representing a unique financial concept. If a financial concept is truly unique, it will always have the same value in the same period for the same business entity. (In fact, this is a useful conceptual test to determine whether an element created *is* unique. If it can have more than one value in the same period for the same business entity, then it is not unique.) Technically, XBRL operates like a database. Within one period for a single business entity, an element can, and logically must, have only one value. When tagging a value for an element, it applies no matter where or how many times that element is used in a calculation. The appearance of the value when rendered may change depending on whether it has been scaled or rounded, and its sign can depend on which statement it appears in, but there is only one underlying value.

4.2.2 Relationship Groups

In the XBRL US GAAP Taxonomy, each distinct statement, disclosure, and schedule is in its own [relationship group](#). There are approximately thirty statements and fifty disclosures; by convention, about ten SEC schedules for article 12-04, 12-09 and others are in relationship groups that are each treated as disclosures.

Relationship groups not only organize the information in the taxonomy, but also allow an element to have more than one set of relationships. Any one element may appear with different parents and children in different statements and disclosures. In both presentation and calculation relationships, a parent element can have only one set of children. Even within a single statement or disclosure, more than one set of children may add up to the same parent element. For example, Figure 30 shows Deposits broken down into two financial reporting categories.

Figure 30 Deposits Example (Preparer's Original Layout)

Deposits:	
Demand Deposits	\$130
Time Deposits	70
Deposits	\$200
Deposits:	
Retail Deposits	\$120
Wholesale Deposits	80
Deposits	\$200

Figure 31 shows how a preparer would model this using presentation and calculation relationships, and how facts would be checked for calculation inconsistency. All of the presentation relationships can appear together in a single group, so long as two different abstract elements are used as headings. The calculation relationships are partitioned into three separate groups, conventionally called a "main"

group with “alternatives”. Groups such as these already exist in the XBRL US GAAP Taxonomy, and a preparer may create any number of additional groups in an extension.

Figure 31 Deposits Example, Presentation and Calculation Relationships

Presentation Relationships		Calculation Relationships	
Group: Main		Group: Main	
Deposits by Type [Abstract]		Deposits	200
Demand Deposits	130	+ Demand Deposits	130
Time Deposits	70	+ Time Deposits	70
Deposits, Total	200		
Deposits by Customer [Abstract]		Group: By Customer Alternative	
Deposits, Retail	180	Deposits	200
Deposits, Wholesale	20	+ Deposits, Retail	180
Deposits, Total	200	+ Deposits, Wholesale	20

Each of the three reported categories will be checked separately for consistency with the Customer Deposits total of \$200. In the presentation relationships, all four elements are recognized as children of their respective parents. The calculation relationships are partitioned into two “Relationship Groups” or simply “Groups”.

Had the calculations not been partitioned in this way, all four components of “Deposits” would have summed to 400, causing a calculation inconsistency with the reported value of 200.

Similarly, had the presentation relationships not had two separate abstract elements, there would have been no way to distinguish which set of facts belonged with which calculation.

4.3 Calculation Weights

In the XBRL US GAAP Taxonomy, each calculation relationship between a parent element and a child is assigned a [weight](#). This weight indicates whether a child element is added or subtracted to compute its parent element. *Weight is not a property of an element. Weight is a property of a specific calculation relationship in a specific relationship group.* Weight can be equal to either a positive 1 (+1) or a negative 1 (-1), indicating that the element’s value is to be added or subtracted when computing the parent total. Whether it is added or subtracted is solely dependent on whether it increases or decreases the calculated total of the parent element. A calculation parent having a credit balance attribute will therefore be increased by a child with a credit balance attribute, and reduced by a child with a debit balance attribute. Similarly, a calculation parent having a debit balance attribute will be increased by a child with a debit balance attribute, and reduced by a child with a credit balance attribute. Figure 32 shows a simple example.

Figure 32 Calculation Weights (Calculation Relationships)

	Weight	Explanation
Inventory, Net	n/a	No parent; no relationship to assign a weight to
Inventory, Finished Goods	+1	Gross amount is added
Inventory, Raw Materials	+1	Gross amount is added
Inventory Valuation Reserves	-1	Reserves are <i>subtracted</i> to arrive at Net

The calculation weight rules maintain consistency with the balance type when it is present. The logic of these rules is based on the double entry bookkeeping system. A few elements in the taxonomy do not have a balance type, so they can participate in any summation whether it is +1 or -1. Figure 33 summarizes the calculation weight rules.

Figure 33 Table of Calculation Relationship Weight Rules

Child Balance	Parent Balance	Calculation Weight
Debit	Debit	+1
Debit	Credit	-1
Credit	Debit	-1
Credit	Credit	+1
(none)	Debit or Credit or (none)	-1 or +1
Debit or Credit or (none)	(none)	-1 or +1

Figure 34 illustrates how weight determines whether child elements are added to, or subtracted from, a calculation parent (Accounts Receivable) to arrive at the total:

- Inventory, Net = Inventory, Finished Goods + Inventory, Raw Materials – Inventory Valuation Reserves

Figure 34 Calculation Relationship Weights Example

	Calculation Weight	Balance Type
Assets, Current	n/a	Debit
Cash, Cash Equivalents, and Short-term Investments	+1	Debit
Marketable Securities, Current	+1	Debit
Receivables, Net	+1	Debit
Inventories, Net	+1	Debit
Inventory, Finished Goods	+1	Debit
Inventory, Raw Materials	+1	Debit
Inventory Valuation Reserves	-1	Credit
Deferred Tax Assets, Net, Current	+1	Debit
Other Assets, Current	+1	Debit

Figure 34 also shows that “Inventories, Net” is simultaneously a child of “Assets, Current” and a parent of “Inventory, Finished Goods” and others in the calculation.

Calculation weight rules describe only how a child element contributes to its *immediate* parent, *not* its “grandparent” or other “ancestors”. As a result, the calculation weight assigned to the relationship between “Inventories, Net” and “Inventory Valuation Reserves” in Figure 34 has no relationship to the calculation parent “Assets, Current”—its only relationship is to “Inventories, Net”.

Understanding how the calculation weight rules work is crucial to tagging values in an instance document, as discussed further in [Section 7, Creating Instance Documents](#).

5 USING TABLES

XBRL-enabled software may have features to simplify working with tables, but this portion of the guide provides preparers with enough detail to understand tables regardless of the specific software.

As discussed in [Section 3, Understanding and Using Taxonomies](#), tables provide a way to capture multidimensional relationships among elements. Multidimensional information is often presented as a table. Figure 35 is an example of a table with two axes: the Available-for-Sale securities line items axis and the type of Available-for-Sale security axis.

Figure 35 XYZ Company and Subsidiaries, Available-for-Sale Securities Reconciliation of Fair Value (Original Preparer Layout)

December 31, 2013	Available-for-Sale			Total
	US Treasury Notes	Corporate Debt Securities	Equity Securities	
Cost	\$2,345	\$528	\$1,552	\$4,425
Gross Unrealized Gains	—	144	498	642
Gross Unrealized Losses	—	23	186	209
Estimated Fair Value	\$2,345	\$649	\$1,864	\$4,858

Within the line items axis, there are four line items (cost, gross unrealized gains, gross unrealized losses, and estimated fair value). Within the axis of type of Available-for-Sale security, there are three members of a domain, representing three types of securities (US Treasury Notes, Corporate Debt Securities, and Equity Securities), and the total for the three members of the domain. The XBRL US GAAP Taxonomy distinguishes between the line items axis, which has financial reporting elements (much as they appear anywhere in the taxonomy), and the domain members, which are types or subcategories of items described by the financial reporting elements. Tables can also include aggregated amounts for their line items (the total column in Figure 35). Figure 36 presents an illustration of these terms ([axis](#), [domain](#), and [member](#)) and what they represent within a table.

Figure 36 Elements of a Table

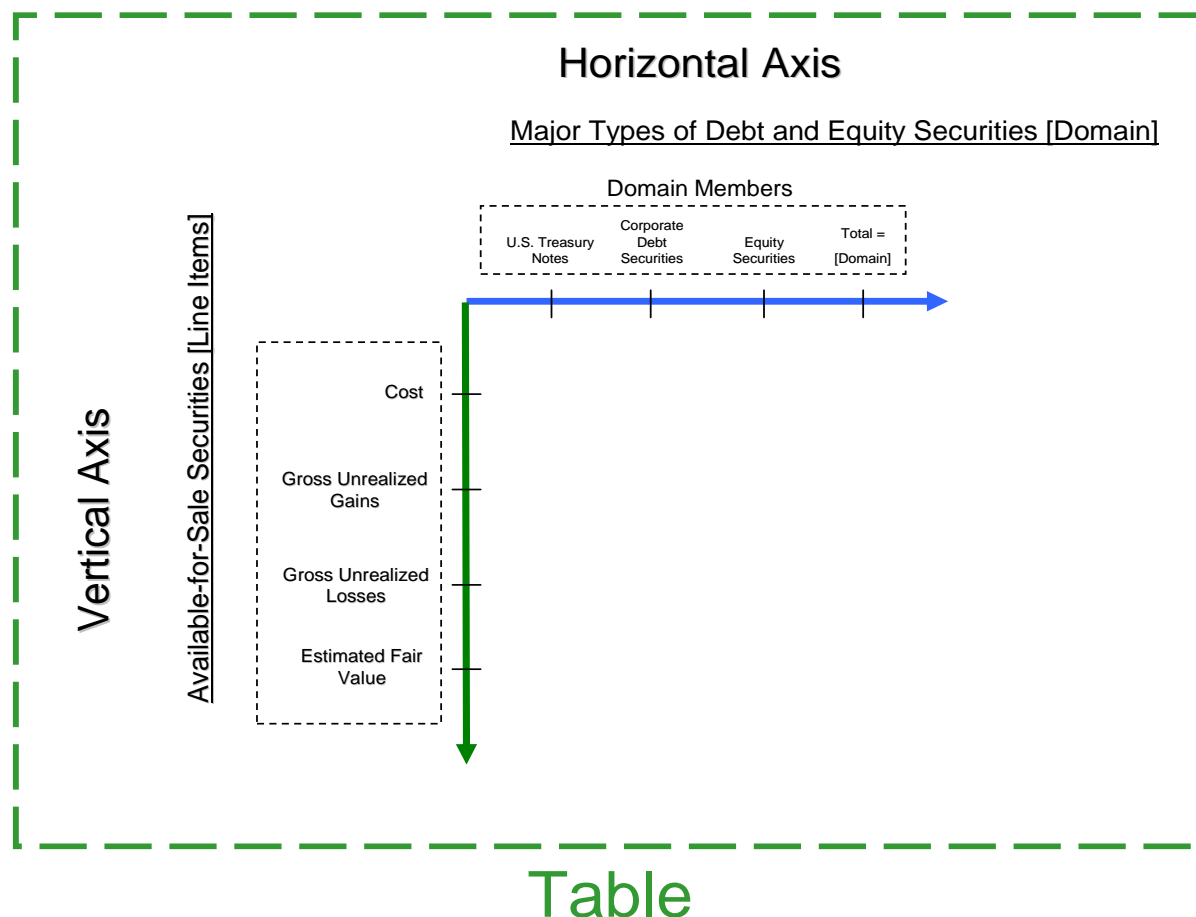

As Figure 36 shows, the following elements are used to define an XBRL table:

- **Table:** A table element represents the overall “table” and is the parent element for axes. A helpful way to think of the concept of a table is to picture a blank spreadsheet with empty cells.
- **Axis:** A table can have any number of axes. Each axis must have at least one domain.
- **Line Items:** Line items are elements that appear on the vertical axis of an XBRL table. Every table must have exactly one abstract element ending with “[Line Items]”.
- **Domain:** A domain is the set of all domain members appearing along an axis and also represents the total of values of all domain members.
- **Domain Members:** A domain member is an element that appears on an axis other than the vertical axis of an XBRL table. In a two-dimensional table, domain members represent elements on the horizontal axis.

Figure 37 overlays the appropriate table element on each part of the table from Figure 35.

Figure 37 XYZ Company and Subsidiaries, Available-for-Sale Securities Reconciliation of Fair Value (Published Financial Statement View with Table Overlay)

December 31, 2013	Available for Sale			
	U S Treasury Notes	Corporate Debt Securities	Equity Securities	Total
Cost				
Gross Unrealized Gains				
Gross Unrealized Losses				
Estimated Fair Value				

Figure 37 represents a table with two axes. Each axis also has a domain (only the type domain is labeled). The domain members (conventionally, the horizontal axis) include US Treasury Notes, Corporate Debt Securities, and Equity Securities. The Total is not a separate domain member; it is represented by the domain element. The line items (conventionally, the vertical axis) include Cost, Gross Unrealized Gains, Gross Unrealized Losses, and Estimated Fair Value.

5.1 Table Elements and Relationships

XBRL tables are defined using dimensional relationships and must adhere to the structure shown in Figure 38. The XBRL US GAAP Taxonomy also has table elements that appear in slightly different *presentation* relationships, but this is to facilitate browsing and review; *only* the dimension relationships matter to XBRL-enabled software.

Figure 38 Parent-Child Table Structure in Dimensional Relationships

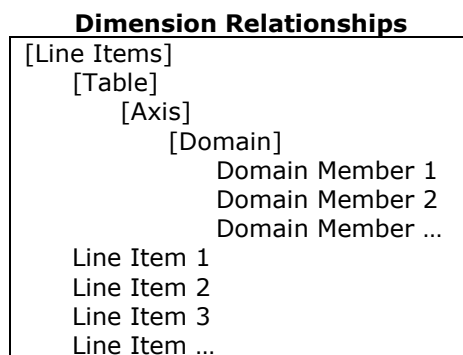

The following material presents an explanation of each of the elements in Figure 38.

5.1.1 Line Items Abstract Element

In the XBRL US GAAP Taxonomy each table has exactly one abstract element whose standard label ends with "[Line Items]". The children of the Line Items element are the table element and all the line items: the monetary, string, decimal, and other types of elements that appear along the vertical axis.

5.1.2 Table Element

The XBRL table is an abstract element, and the axis, domain, and member elements must be subordinate to it (that is, child, grandchild, great grandchild, and so forth). A table is used only if preparers need to represent information that is characterized in two or more axes.

5.1.3 Axes Are Children of Table Elements

Axes are abstract elements that are children of table elements and represent the different ways in which data can be classified (for example, actual [as opposed to plan or forecast], type of security, or class of fixed asset). A table can have an unlimited number of axes, but the more axes it has, the more difficult it will be to work with for preparers and other users of the extension. Regardless of how many axes a table has, the rules for their operation are the same. For clarity, this guide generally limits discussion to the horizontal axis and the vertical axis.

An axis cannot be the child of more than one table.

5.1.4 A Domain Is a Child of an Axis

A domain represents the collection of elements along a given axis.

A domain element may appear as the child of any number of axis elements. For example, "Equity Securities [Domain]" could be the child of both "Trading Securities [Axis]" and "Available-for-Sale Securities [Axis]".

An axis element must have no more than one domain child anywhere in the taxonomy. For example, "Trading Securities [Axis]" cannot have the child "Equity Securities [Domain]" in one place and the child "Financial Instrument [Domain]" in another.

5.1.5 Domain Members Are Children of a Domain

Domain members are the individual elements that appear along an axis. Because every domain is automatically the default "total" domain member, preparers must not create an explicit "total" domain member as a new element. The domain-member relationship is analogous to the calculation relationship: the domain represents the sum of values of its member children.

A domain member element may appear as the child of any number of domain elements.

Returning to Figure 37, if a business entity reports a fair value for the "Major Types of Debt and Equity Securities [Domain]", as well as a value for each of the three members, then the value for the domain should be the sum of the three other values. But there the analogy ends; XBRL-enabled software does not perform a consistency check to determine that all values reported for specified domain members (in this example, the values for the three major types of debt and equity securities) sum to the total value.

5.1.6 Line Items Are Children of the Line Items Abstract Element

For reasons internal to the [XBRL specification](#), in the dimensional relationships, both domain members and line items are organized into hierarchies using the domain-member relationship. However, domain members and line items are not interchangeable. A domain member cannot be used to tag data in the same way that other elements can.

5.1.7 Each Domain Element Is the Default Member of an Axis

A line item that is not specifically associated with a domain member is assumed to be the total for that domain. That is, if a line item is not reported as being a disaggregated amount associated with some other member, then it is assumed to be the default total. If an instance document contains a value that is not otherwise specified to relate to a specific domain member, then XBRL-enabled software will treat it as an amount for the reporting entity as a whole. In short, if the preparer ignores an axis of a table in an instance document, then XBRL software ignores that axis too.

Some software tools show the domain element as the child of the axis element *twice*: once as the domain element, and again as the default. This is technically correct. Figure 39 includes an asterisk next to a domain element as a user might see it twice in certain software products. Because an axis

element must have no more than one domain child anywhere in the taxonomy, it follows that there can only be one default.

The example in Figure 36 has been discussed from a theoretical perspective, but how is it represented in the XBRL US GAAP Taxonomy? The taxonomy contains a table for this disclosure, including many elements not used in the example. Figure 39 presents a copy of the table containing *only* the necessary elements in the desired order; this process is described in [Section 6, Creating Extensions](#).

Figure 39 Available-for-Sale Securities Table in the XBRL US GAAP Taxonomy (Dimension Relationships)

Schedule of Available-for-Sale Securities [Line Items]
Schedule of Available-for-Sale Securities [Table]
Schedule of Available-for-Sale Securities, Major Types of Debt and Equity Securities [Axis]
Major Types of Debt and Equity Securities [Domain]
US Treasury Securities [Member]
Corporate Debt Securities [Member]
Equity Securities [Member]
Major Types of Debt and Equity Securities [Domain] *
Available-for-Sale Securities, Amortized Cost
Available-for-Sale Securities, Gross Unrealized Gains
Available-for-Sale Securities, Gross Unrealized Losses
Available-for-Sale Securities, Noncurrent

Figure 40 shows how XBRL-enabled software might display the table as constructed in Figure 39 above. The exact view will vary based on the software used.

Figure 40 Available-for-Sale Securities Table in the XBRL US GAAP Taxonomy (Tabular)

	Major Types of Debt and Equity Securities			
	US Treasury Securities	Corporate Debt Securities	Equity Securities	(Implicit Total)
Available-for-Sale Securities, Amortized Cost				
Available-for-Sale Securities, Gross Unrealized Gains				
Available-for-Sale Securities, Gross Unrealized Losses				
Available-for-Sale Securities, Noncurrent				

5.1.8 Calculations within Tables

Calculations within tables follow the same rules as calculations outside tables except that the relationships can only be defined between line items (see [Section 4, Using Taxonomy Calculations](#)). Calculations do not operate across domain members. In a table such as Figure 40 above, with line items on the vertical axis and domain members across the horizontal axis, this means that an “implicit total” such as that indicated in the rightmost column is not checked for consistency with the sum of disaggregated values in the other columns (US Treasury Securities, Corporate Debt Securities, and Equity Securities).

5.1.9 Presentation of a Table

XBRL tables are defined using dimension relationships, not presentation relationships. By convention, the XBRL US GAAP Taxonomy has a copy of every dimension relationship in the form of a parent-child presentation relationship to facilitate locating elements by providing all the elements within a single set of relationships. The relationship between the “line items” element and the line items is the same as in the dimension relationships. Because each of the line items has a corresponding presentation relationship, these line items can be used without any corresponding domain members. That is, a line item can be used in the same manner as other numeric and textual elements in the taxonomy.

One difference between the dimension and presentation relationships is that the dimensional relationship includes the [Line Items] abstract element as the parent of the [Table] element, which is harder to understand than if the [Table] were the parent. Therefore, in the presentation relationships, whose main purpose is to facilitate locating elements, the [Table] is the parent of the [Line Items]. Other than that, Figure 39 is nearly the same as the corresponding presentation relationship shown in Figure 41.

Figure 41 Available-for-Sale Securities Table in the XBRL US GAAP Taxonomy (Presentation Relationships)

Schedule of Available-for-Sale Securities [Table]
Schedule of Available-for-Sale Securities, Major Types of Debt and Equity Securities [Axis]
Major Types of Debt and Equity Securities [Domain]
US Treasury Securities [Member]
Corporate Debt Securities [Member]
Equity Securities [Member]
Schedule of Available-for-Sale Securities [Line Items]
Available-for-Sale Securities, Amortized Cost
Available-for-Sale Securities, Gross Unrealized Gains
Available-for-Sale Securities, Gross Unrealized Losses
Available-for-Sale Securities, Noncurrent

5.1.10 Rotating Axes

In the examples in this section, the vertical axis contains the line item elements, and the horizontal axis disaggregates the elements by type of security. Figure 42 shows ABC Company's table of debt and equity securities from note 3 of its financial statements.

Figure 42 ABC Company and Subsidiaries, Note 3: Marketable Debt and Equity Securities

(In thousands)	Cost	Gross Unrealized Gain	Gross Unrealized Losses	Estimated Fair Value
December 31, 2013:				
Available-for-Sale:				
US Treasury securities	\$4,163	\$—	\$—	\$4,163
Corporate debt securities	961	253	58	1,156
Equity securities	302	729	67	964
Total	\$5,426	\$982	\$125	\$6,283
December 31, 2012:				
Available-for-Sale:				
US Treasury securities	\$2,767	\$—	\$—	\$2,767
Corporate debt securities	1,219	64	57	1,226
Equity securities	831	117	309	639
Total	\$4,817	\$181	\$366	\$4,632

The table structure of Figure 42 differs from the XBRL US GAAP Taxonomy table structure (Figure 40) in that the axes are switched. Some software tools allow preparers to "pivot" the axes to conform to the format of their financial report. Pivoting or flipping is purely presentational and does not change the meaning of the axes, although it may better reflect the presentation within the financial statement. Domain members remain domain members and line items remain line items, so the technical characteristics of the axes remain unchanged and the data can be interpreted by XBRL-enabled applications without regard to the original presentation.

Rule: Do not create a new XBRL table merely because the axes of a table are rotated.



5.1.11 Tables with More Axes

In addition to the line items axis that a table must always have, a table may have two or more other axes. The XBRL US GAAP Taxonomy has a small number of tables with more than one additional axis element. Figure 43 shows dimension relationships from relationship group "790000 – Disclosure – Segment Reporting", from the table "Schedule of Entity-Wide Revenue by Major Customers, by Reporting Segments", with four additional axis elements representing a specific entity's two major reporting segments and two major customers. The table only has one line item, representing the amount of revenue.

Figure 43 Schedule of Entity-Wide Revenue by Major Customers, by Reporting Segments (Dimension Relationships with Entity-Specific Extensions)

Entity-Wide Revenue, Major Customer [Line Items]
Schedule of Entity-Wide Revenue by Major Customers, by Reporting Segments [Table]
Entity-Wide Revenue by Reporting Segment [Axis]
Reporting Segment [Domain]
Custodial Services [Member]
Office Furniture [Member]
Entity-Wide Revenue by Major Customer [Axis]
Description of Major Customer [Domain]
US Federal Government [Member]
State of Maryland [Member]
Entity-Wide Revenue, Major Customer, Amount

In this table, the reporting entity would characterize each revenue amount as to whether it refers to one or both segments, and whether it refers to one or both major customers. These characteristics are, in fact, the two axes of the table in addition to the revenue amount line item. This is usually done through a tabular layout. Figure 44 shows three of the numerous alternatives appropriate for the entity.

Figure 44 Using Multiple Axes in Alternative Layouts

(In thousands)	Custodial Services		Office Furniture	
	US Federal Government	State of Maryland	US Federal Government	State of Maryland
Entity-Wide Revenue, Major Customer, Amount				

(In thousands)		
Entity-Wide Revenue, Major Customer, Amount	US Federal Government	State of Maryland
Custodial Services		
Office Furniture		
Reporting Segment [Domain]		

(In thousands)		Custodial Services	Office Furniture
Entity-Wide Revenue, Major Customer, Amount	US Federal Government		
	State of Maryland		
	Major Customer [Domain]		

The layouts differ from the XBRL US GAAP Taxonomy table only in that the axes are rotated and grouped in different ways along the horizontal and vertical axes. This rotation is purely presentational and does not change the meaning of the axes nor the line items. The rotation used by the preparer may be based on which subtotals are shown and which are not.

5.1.12 Mapping to Tables

When a preparer maps the notes to a financial statement, situations will arise when the line items and domain members of tables in the XBRL US GAAP Taxonomy do not seem to be a good match. The two most common mismatches are handled in the company's extension taxonomy:

1. A note has data in a paragraph of text, but the XBRL US GAAP Taxonomy provides the relevant line items inside of a table. [Section 6.6](#), "*Method 6: Add new relationships between elements*", explains how line items from inside a table can be used anywhere.
2. A note has information in a table, but the relevant line items do not appear in a table in the XBRL US GAAP Taxonomy. [Section 6.10](#), "*Method 10: Add a new table*", explains how to arrange the line items into a table.

6 CREATING EXTENSIONS

Public taxonomies such as the XBRL US GAAP Taxonomy cannot always meet the precise needs of every individual financial report. For this reason, XBRL is designed to be extensible, allowing preparers to create an extension taxonomy that adds to the public taxonomy.

Creating an extension taxonomy is done differently in different software products. Details are provided in [Appendix C](#), *Extension Naming*. The main points are:

1. An extension consists of several files, whose names should conform to EDGAR file name conventions. These begin with the company ticker symbol, contain the date of the end of the latest reporting period in the filing, and have other constraints detailed in [Appendix C](#).
2. The extension taxonomy has a unique [namespace](#), which looks like a web address although it is not. The form for an extension taxonomy namespace is: "http://xbrl.ABC.com/2012".
3. The extension taxonomy is based on one of the industry entry points as explained in Section 3.1.4, "More about Entry Points".

Figure 45 lists the methods for extending a taxonomy to meet specific reporting needs. The methods are listed in order of increasing levels of impact on the reusability of the extension; creating company-specific relationship groups has much less impact than creating company-specific text block elements. Creating a reusable taxonomy will reduce the time and effort required to prepare subsequent financial reports in XBRL.

Figure 45 Methods of Extending a Taxonomy

1. Create relationship groups. (* used in every extension)
2. Change the ordering of relationships. (* used in every extension)
3. Change the preferred label used on a presentation relationship.
4. Add a new abstract heading element to group elements into presentation relationships.
5. Add or change element labels.
6. Add a new relationship between existing elements (for example, creating a calculation for multiple elements, or copying an element from a disclosure to the face of the financial statements).
7. Suppress or change a parent-child relationship.
8. Add a new domain member element and its definition to an axis.
9. Add a new axis element and its definition to a table.
10. Add a new table element and its definition.
11. Add a new line item (such as a monetary, per-share, or other amount) element and its definition.
12. Add a new string or text block and its definition.

The first two methods, marked with asterisks, will be used in every company extension. The other methods will depend on the facts and circumstances of the preparer. The order of this list emphasizes the need to consider alternatives other than creating new elements, as in methods 8 through 12.

Rule: Use elements from the XBRL US GAAP Taxonomy whenever possible.



Each of these methods of extending the XBRL US GAAP Taxonomy will be described below, including the motivation for the change, its impact, and how to execute the change.

Rule of Thumb: Validate the taxonomy often to avoid spending time fixing errors in later stages of preparing an extension taxonomy.



A figure at the end of each "method" section interprets error or warning messages that preparers may see while editing the extension taxonomy. Preparers might never see any of these messages, but as

any software user knows, sometimes error messages contain unfamiliar technical terms or ambiguous phrasing. The tables in these sections are described in general terms without reference to any specific software product.

6.1 Method 1: Create Relationship Groups

Creating a new relationship group creates a “clean slate” where preparers can assemble custom presentation or other relationships. Presentation and calculation relationships in different groups do not interact with each other. Preparers may create new relationship groups with little or no impact on the reusability of the extension.

The group needs a name that resembles a namespace; to create a readable name, preparers should start with the extension namespace for the extension taxonomy, add “/role/”, then end with a phrase in [camel case](#). Changing the group name later is time consuming, and some software will not allow it at all, so preparers should take care to check spelling and other aspects of the name at the moment the group is created.

The group also needs a human-readable description. This is easier to change than the name. It should start with a number to facilitate sorting into a familiar order. Figure 46 shows a typical set of new relationship groups, in which the numbering and naming convention of the XBRL US GAAP Taxonomy is followed, but the groups are created by and specific to ABC Company.

Figure 46 Suggested New Relationship Groups

Suggested Group Name	Group Description
http://xbrl.abc.com/2007/role/StatementOfEarnings	000010 – Statement – Statement of Earnings
http://xbrl.abc.com/2007/role/BalanceSheet	000020 – Statement – Balance Sheet
http://xbrl.abc.com/2007/role/CashFlowStatement	000030 – Statement – Cash Flow Statement
http://xbrl.abc.com/2007/role/StatementOfEquity	000040 – Statement – Statement of Equity
http://xbrl.abc.com/2007/role/NotesToConsolidatedStatements	000050 – Disclosure – Notes to Consolidated Statements

The table below interprets error or warning messages about relationship groups that preparers may encounter while editing the extension taxonomy.

Figure 47 Extension Taxonomy Validation Messages about Relationship Groups

Severity	Key Phrases	Solution
Error	Illegal “URI” or “Role” or “Extended Link”.	Verify that the name contains nothing but letters, numbers, and forward slash characters after the “http://” prefix.
Error	“URI” or “Role” already exists; “Extended Link” redefined.	Verify that the name is not one in use already, either in the extension or in the XBRL US GAAP Taxonomy.
Warning	Non- ASCII characters	Verify that the description has only simple formatting.

6.2 Method 2: Change the Ordering of Relationships

A simple change with little impact on the extension’s reusability is to reorder children in a list underneath a common parent. These changes would include reordering a simple list of details and changing the layout of a table by reordering elements. Changing the order has no impact on the meaning of the elements.

The most common reason to change the order of presentation relationships is to match an existing report. It is also helpful to change the order of calculation relationships so that the elements appear in a familiar order, because this can help when diagnosing and resolving calculation inconsistencies. Figure 48 shows a simple example in which the XBRL US GAAP Taxonomy’s Banking and Savings Institution entry point has elements in a certain order.

Figure 48 Reordering Children

BASI Taxonomy, Cash Flow Statement	Desired Cash Flow Statement Order
Net Cash Provided by (Used in) Investing Activities, Continuing Operations [Abstract]	Net Cash Provided by (Used in) Investing Activities, Continuing Operations [Abstract]
...	...
<ul style="list-style-type: none"> • Payments for (Proceeds from) Mortgage Servicing Rights [Abstract] 	<ul style="list-style-type: none"> • Payments for (Proceeds from) Investments [Abstract]
<ul style="list-style-type: none"> • Payments for (Proceeds from) Investments [Abstract] 	<ul style="list-style-type: none"> • Payments for (Proceeds from) Mortgage Servicing Rights [Abstract]
...	...

The table below interprets error or warning messages about presentation relationships that preparers may encounter while editing the extension taxonomy.

Figure 49 Validation Messages about Presentation Relationships

Severity	Key Phrases	Solution
Error	"Directed Cycle" or "Loop"	This means an element has been accidentally moved or copied to a position where it appears as a child or descendant of itself. Check the error message to find the offending element, detach it from its parent, verify that the error has been resolved, and then continue editing.
Warning	"Duplicate Values of the Order Attribute"	To put children in sequence, there is a number on each relationship called an "order"; when there is more than one child of a single element with the same order number, other XBRL software cannot determine the right sequence. The software may not display the order number by default, but it always provides a way to repair this.
Warning	"Parent has Multiple Occurrences of a Child without Preferred Labels"	Only one situation warrants having an element appear as the child of the same parent more than once: when the element is both the beginning and an ending balance of a roll-forward. Either remove one of the children or set the preferred labels (see Method 3) differently to resolve the warning.

6.3 Method 3: Change the Preferred Label Used on a Presentation Relationship

Preparers may select the label type to display on any presentation relationship. If a presentation relationship does not specify a preferred label type, the standard label will be used. Providing a preferred label on a presentation relationship improves readability of the taxonomy, and as with most extensions involving only presentation, has little impact on reusability.

Figure 50 illustrates the use of some label types most commonly used in extensions. There is a parent-child relationship from "Goodwill [Roll-Forward]" to each of seven children. In this example every relationship specifies a preferred label.

Figure 50 Example of Preferred Labels, with Impact on Displayed Data

Preferred Label	Displayed Label	Displayed Data
Goodwill [Roll-Forward]		
Period Start	Goodwill, Beginning Balance	\$ 1,522
Terse	Additions	277
Negating	(Less) Impairment	(24)
Negating	(Less) Written Off	(139)
Terse	Allocation Adjustment	(18)
Total	Goodwill, Period Increase (Decrease), Total	96
Period End	Goodwill, Ending Balance	\$ 1,618

Example Element	Label Type	Label
Goodwill	Standard	Goodwill
Goodwill	Period Start	Goodwill, Beginning Balance
GoodwillAcquiredDuringPeriod	Period End	Goodwill, Ending Balance
GoodwillAcquiredDuringPeriod	Standard	Goodwill, Acquired During Period
GoodwillImpairmentLoss	Terse	Additions
GoodwillImpairmentLoss	Standard	Goodwill, Impairment Loss
GoodwillWrittenOffRelatedToSaleOfBusinessUnit	Negating	(Less) Impairment
GoodwillWrittenOffRelatedToSaleOfBusinessUnit	Standard	Goodwill, Written Off Related to Sale of Business Unit
GoodwillAllocationAdjustment	Negating	(Less) Written Off
GoodwillAllocationAdjustment	Standard	Goodwill, Allocation Adjustment
GoodwillPeriodIncreaseDecrease	Standard	Other
GoodwillPeriodIncreaseDecrease	Total	Goodwill, Period Increase (Decrease)

Software products vary as to how the user changes the preferred label type on a presentation relationship; the simplest interface is a “drop down” list showing the label type.

Label types on an element differ from the *preferred label of a presentation relationship*. Merely giving an element a new label with a type other than its standard label does not change how it is displayed. To change the label that is displayed, preparers must also change the preferred label on a presentation relationship. Preparers cannot specify a preferred label on a presentation relationship unless the child element already has that label type.

If a presentation relationship has a preferred label type that is a [negating label](#), then numbers on the same row as the child line item will all have their signs flipped. A negating label should be used when the sign of a number in the source financial statement is different than the sign of the element. Calculation relationships and weights should not be changed, and elements should not be added just to accomplish a sign flip. [Section 7.7](#) shows an example of negating labels in a cash flow statement.

It is important to understand the convention that labels of US GAAP Taxonomy elements follow to communicate the intended sign of the element value. The pair of words “Increase (Decrease)” means that a positive value is an increase in the underlying balance. The pair of words “Gain (Loss)” likewise means that a gain is represented as a positive number. “Income (Loss)” and other variations also occur in standard labels; in all, the first word indicates the positive number and the second indicates the negative. In negating labels, the order of the words does not change, but the placement of the parentheses does. For example, in Figure 15 the standard label is “Increase (Decrease) in Prepaid Expense”, while its negating labels begin with “(Increase) Decrease in Prepaid Expense”.

Parentheses are absent from a standard label when the value assigned to that element is virtually always zero or positive. With that in mind, the word “Adjustment” in a standard label signals the preparer to take care to understand the intended sign of that element’s value, so that the instance document contains data that conveys the preparer’s intended direction of those adjustments.

The table below interprets error or warning messages about preferred labels that preparers may encounter while editing the extension taxonomy.

Figure 51 Extension Taxonomy Validation Messages about Preferred Labels

Severity	Key Phrases	Solution
Error	Missing, undefined or illegal "label role" or type	Verify that the child element in a presentation relationship with a preferred label type actually has a label of that type.
Warning	More than one period ending or beginning label type or role preferred	If the parent element is meant to have the same child in two positions, verify that one has a preferred period start label and the other has a preferred period end label.

Several of the label types influence how the data in an instance document will be displayed. [Section 7, Creating Instance Documents](#), covers more on the display of instance data.

6.4 Method 4: Add a New Abstract Heading Element to Group Elements into Presentation Relationships

Abstract elements in presentation relationships help organize information. XBRL software will display the abstract element as a heading, and the child elements will be indented as in Figure 52, row 19. Figure 21 (ABC Company and Subsidiaries Current Assets, Presentation Relationships) and Figure 31 (Deposits Example, Presentation and Calculation Relationships) illustrated the use of an abstract element as a heading. As with most extensions involving only presentation, they have little impact on reusability.

Figure 52 An Abstract Element Created in an Extension

Period Start Date - End Date	1/1/2004 - 12/31/2004	XBRL Field
17	Realized Capital Gains (Losses), Net	\$291,000,000 us-gaap:GainLossesOnSalesOfAssets
18		\$22,700,000,000 us-gaap:Revenues
19	Policy Benefits, Losses and Expenses (Abstract)	hig:PolicyBenefitsLossesAndExpensesAbstract
20	Benefits, Losses and Loss Adjustment Expenses	\$13,640,000,000 us-gaap:PolicyholderBenefitsAndClaimsIncurredNet
21	Amortization of Deferred Policy Acquisition Costs and Present Value of Future Premiums	\$2,943,000,000 hig:AmortizationOfDeferredPolicyAcquisitionCostsAndPresentValueOfFuturePremiums
22	Insurance Operating Costs and Expenses	\$2,776,000,000 us-gaap:OperatingCostsAndExpenses
23		\$251,000,000 us-gaap:InterestExpense
24		\$675,000,000 us-gaap:OtherNonoperatingExpense
25	Benefits, Losses and Expenses	\$20,185,000,000 hig:PolicyBenefitsLossesAndExpenses
26	Income before Income Taxes and Cumulative Effect of Accounting Change	\$2,523,000,000 us-gaap:IncomeLossFromContinuingOperationsBeforeIncomeTaxes
27	Income Tax Expense	\$385,000,000 us-gaap:IncomeTaxExpenseBenefit
28	Income before Cumulative Effect of Accounting Change	\$2,138,000,000 us-gaap:IncomeLossBeforeExtraordinaryItemsAndCumulativeEffectOfAccountingChange
29		-\$23,000,000 us-gaap:CumulativeEffectOfChangeInAccountingPrinciples
30	Net Income	\$2,115,000,000 us-gaap:NetIncomeLoss
31	<i>Net Income, Earnings Per Share, Basic (Abstract)</i>	us-gaap:EarningsPerShareBasicAbstract
32	Income before Cumulative Effect of Accounting Change, Per Outstanding Share	7.32 us-gaap:IncomeLossBeforeExtraordinaryItemsAndCumulativeEffectOfAccountingChangePerShare
33	Cumulative Effect of Accounting Change, net of Tax, Per Outstanding Share	-0.88 us-gaap:CumulativeEffectOfChangeInAccountingPrinciplesPerShare
34	Net Income, Earnings Per Share, Basic	7.24 us-gaap:EarningsPerShareBasic
35	<i>Net Income, Earnings Per Share, Diluted (Abstract)</i>	us-gaap:EarningsPerShareDilutedAbstract
36	Income before Cumulative Effect of Accounting Change, Per Diluted Share	7.2 us-gaap:IncomeLossBeforeExtraordinaryItemsAndCumulativeEffectOfAccountingChangePerShare
37	Cumulative Effect of Accounting Change, net of Tax, Per Diluted Share	-0.88 us-gaap:CumulativeEffectOfChangeInAccountingPrinciplesPerShare
38	Net Income, Earnings Per Share, Diluted	7.12 us-gaap:EarningsPerShareDiluted
39	Weighted Average Common Shares Outstanding	292,300,000 us-gaap:WeightedAverageNumberOfSharesOutstanding
40	Weighted Average Common Shares Outstanding and Dilutive Potential Common Shares	297,000,000 us-gaap:WeightedAverageNumberOfDilutedSharesOutstanding
41	Cash Dividends Declared, Per Share	1.13 us-gaap:CommonStockDividendsPerShareDeclared

A user of an instance document may assume that the abstract describes its children. Accordingly, preparers should consider whether the abstract provides an appropriate description of its children.

Creating a new abstract element requires defining various attributes. Different software products have different user interfaces to accomplish this, but Figure 53 lists the information that goes into the attributes for any abstract element. However, preparers should always consider changing the label of an existing abstract element before creating a new abstract element.

Figure 53 Attributes of an Abstract Element

Attribute	Example	Description
Element name	BenefitsLossesAbstract	The " camel case " version of the standard label, dropping punctuation; this may be automated by taxonomy software if preparers simply provide a standard label.
Element ID	hig_BenefitsLossesAbstract	Start with the namespace prefix , underscore ("_") and the element name; taxonomy software always automates the creation of the element ID.
Substitution group	Item	Select "item"
Data type	String	Select "string"
Period type	Duration	Select "duration"
Balance type		Leave blank
Abstract	True	Select "true"
Label, Standard	Benefits, Losses [Abstract]	End label with "[Abstract]". Keep punctuation to an essential minimum, do not use carriage returns, and do not begin or end with any kind of spaces.
Definition		(optional for abstract elements)

Once the abstract element has been created, preparers will then add new relationships between it and other elements.

Rule: Include at least one new presentation relationship for every new element in the extension. 

Creating an element with the same name as an element that already exists in the XBRL US GAAP Taxonomy will confuse users of the extension taxonomy and instance documents. However, software does not necessarily test to see whether the element name created in the extension taxonomy is the same as an element in the XBRL US GAAP Taxonomy. Preparers should check for duplicate names if the software does not.

Rule: Do not create an abstract element with the same name or standard label as an existing abstract element in the XBRL US GAAP Taxonomy. 

The table below interprets error or warning messages about newly created abstract elements that preparers may encounter while editing the extension taxonomy.

Figure 54 Extension Taxonomy Validation Messages about New Abstract Elements

Severity	Message	Solution
Error	Illegal element name	Element names cannot have spaces or punctuation and cannot begin with a digit; remove these from the name.
Error	Element name in use; element name not unique	There is already an element with that name in the extension. Either reuse the existing element or change the new name.
Error	Non-numeric type cannot have balance	Leave the "Balance type" attribute blank on any abstract element.
Error	Substitution group not compatible with data type ("complex type" "particle restriction" "derivation" "schema" errors)	The substitution group of an abstract is always "item" and its data type always "string". Other combinations may result in this error.
Warning	Label is not unique	Change the label to indicate the purpose of this abstract. For example, Figure 31 showed different abstract elements ("Customer Deposits, Source [Abstract]", "Customer Deposits, Nature [Abstract]") for two different ways of calculating total customer deposits.
Warning	Element ID does not match name	This warning is unlikely because software usually automatically aligns the ID and element name. Change the ID manually.

6.5 Method 5: Add or Change Element Labels

Most software products that open XBRL instance documents will display the labels of the elements used in the instance document. These labels are also used by software that renders instance documents into more familiar, easy-to-read formats. Preparers may change element labels to match the wording on an entity's financial statements to ensure that when the elements are displayed or rendered from an instance document, they match the published financial statements. Consistency between the instance document and the published financial statements has benefits, particularly for reviewers of the instance document. However, there is no requirement that the labels in the instance document exactly match the line items in the financial statements.

The element definition and the references are central to the meaning of an element. Choosing the right element to represent a financial reporting concept is critical, as detailed in [Section 3, Understanding and Using Taxonomies](#). The definition and other assigned attributes for an element are important in choosing the right element. Changing or elaborating on the definition or other attributes, such as references, may force a user to make an additional interpretation of the element and potentially reduce its reusability. Therefore, do not change or add to definitions or references for elements in the existing taxonomies.

Rule: Do not change or add definitions to elements in the XBRL US GAAP Taxonomy.



Rule of Thumb: Do not add references to elements in the XBRL US GAAP Taxonomy.



If the definition of an XBRL US GAAP Taxonomy element is appropriate, and changing a label is all that is needed to use it in an extension, that is much better than creating a new element. The label is additional information to the definition and references. Also, a concept on the financial statements may contain a synonym or variation of a term already appearing in the element's standard label in the XBRL US GAAP Taxonomy (for example, "Unearned" instead of "Deferred"). If so, it may *not* be worthwhile to make the effort to change the label. [Appendix D](#) lists terms that are used in the XBRL US GAAP Taxonomy and similar terms that were not used.

Since the label of a line item will apply to all columns of data shown for the item, including the current and subsequent periods, phrases such as "for the period ended October 31, 2009" and "Less allowance of \$42" or "(see Note 12)" must not appear in a label.

Rule: Do not include period-specific or other information likely to change in future periods in the label of an element.



Rule: Do not include parenthetical phrases in the label of an element. Treat parenthetical disclosures as separate line items.



Element labels can be worded in many different ways but still mean the same thing. Changing the label of an element does not affect its underlying meaning or the comparability of data. The label does not define the element and generally does not provide enough information to determine whether an element is appropriate for tagging a financial concept.

Figure 55 shows element label examples taken from a set of sample financial statements published at www.xbrl.us. Most are little more than synonyms or concise rephrasings.

Figure 55 Sample of Element Labels in Extension Taxonomies

Element Label in XBRL US GAAP Taxonomy	Element Label in Sample Extension Taxonomy
Additional Paid in Capital	Additional Paid-in Capital
Adjustments to Reconcile to Income (Loss) from Continuing Operations [Abstract]	Adjustments to Reconcile Net Income to Net Cash Provided by Operating Activities [Abstract]
Cash Flow, Supplemental Disclosures [Text Block]	Supplemental Disclosure of Statement of Cash Flow Information [Text Block]
Cash and Cash Equivalents, Period Increase (Decrease)	Increase (Decrease) in Cash and Cash Equivalents
Cash and Cash Equivalents, at Carrying Value	Cash and Cash Equivalents
Commitments and Contingencies Disclosure [Text Block]	Commitments and Contingencies [Text Block]
Common Stock, Dividends, Per Share, Declared	Cash Dividends Declared, Per Share
Common Stock, Par or Stated Value Per Share	Common Stock, Par value
Communications and Information Technology	Communications and Technology
Concentration Risk Disclosure [Text Block]	Concentration of Risk [Text Block]
Cumulative Effect of Change in Accounting Principle, Net of Tax, Per Diluted Share	Cumulative Effect of Accounting Change, Net of Tax, Per Diluted Share
Cumulative Effect of Change in Accounting Principle, Net of Tax, Per Basic Share	Cumulative Effect of Accounting Change, Net of Tax, Per Outstanding Share
Debt Disclosure [Text Block]	Mortgages and Notes Payable and Contract Rights Payable [Text Block]
Deferred Policy Acquisition Costs and Value of Business Acquired	Deferred Policy Acquisition Costs and Present Value of Future Profits
Deferred Tax Assets, Net	Deferred Income Taxes Assets
Disposal Groups, Including Discontinued Operations, Disclosure [Text Block]	Discontinued Operations and Assets Held For Sale [Text Block]
Long-term Debt	Long-term Borrowings

Instance documents are designed for reliable exchange of interactive data, but an extension taxonomy will never have enough information in it to *allow* (or *force*) users of an instance document to see exactly what they would see in the formatted and printed financial statements. For example, the XBRL US GAAP taxonomy has no element corresponding to the notation "Refer to Notes to Consolidated Financial Statements" that appears at the bottom of a page; XBRL does not even have a way of indicating page boundaries. Preparer effort spent on duplicating original phrasing, layout, and formatting has rapidly diminishing returns. Time is much better spent on accurate element definitions, calculation relationships, and other extension taxonomy features.

Figure 56 and Figure 57, taken from a spreadsheet-based application, illustrate two ways users approach the instance document. In Figure 56, the extension changes the standard label of almost every element to match the original 10-K presentation. The label may convey nuances of meaning, but because the end user can easily see the actual XBRL element name, the custom label is somewhat cosmetic for analytical purposes.

Figure 56 Element Standard Labels Largely Changed by an Extension

3	Period Start Date - End Date	1/1/2004 - 12/31/2004	XBRL Field
25	<i>Noninterest Income [Abstract]</i>		us-gaap:NoninterestIncomeAbstract
26	Security Gains, Net	\$5,344,000	us-gaap:GainLossOnSaleOfSecuritiesNet
27	Service Charges on Deposit Accounts	\$9,383,000	us-gaap:FeesAndCommissionsDepositorAccounts
28	Wealth Management Fees	\$6,201,000	us-gaap:FeesAndCommissionsFiduciaryAndTrustActivities
29	Letter of Credit Fees	\$2,022,000	us-gaap:FeesAndCommissionsOther
30	Insurance Agency Fees	\$4,558,000	us-gaap:InsuranceCommissionsAndFees
31	Mortgage Banking	\$1,391,000	us-gaap:FeesAndCommissionsMortgageBanking
32	Other Noninterest Income	\$5,502,000	us-gaap:NoninterestIncomeOtherOperatingIncome
33	Noninterest Income, Total	\$34,401,000	us-gaap:NoninterestIncome
34	<i>Noninterest Expense [Abstract]</i>		us-gaap:NoninterestExpenseAbstract
35	Salary and Employee Benefits	\$32,845,000	us-gaap:LaborAndRelatedExpense
36	Occupancy, Net	\$4,166,000	us-gaap:OccupancyNet
37	Furniture and Equipment Expense	\$2,916,000	us-gaap:EquipmentExpense
38	Other Taxes	\$2,609,000	stba:OtherTaxes
39	Data Processing	\$3,966,000	us-gaap:CommunicationsAndInformationTechnology
40	Marketing Expense	\$2,399,000	us-gaap:MarketingExpense
41	Amortization of Intangible Assets	\$347,000	us-gaap:AmortizationOfIntangibleAssets
42	FDIC Assessment	\$289,000	us-gaap:FederalDepositInsuranceCorporationPremiumExpense
43	Other Noninterest Expense	\$10,853,000	us-gaap:OtherNoninterestExpense
44	Noninterest Expense, Total	\$60,390,000	us-gaap:NoninterestExpense
45	Income (Loss) before Income Taxes	\$77,359,000	us-gaap:IncomeLossFromContinuingOperationsBeforeIncomeTaxes
46	Income Tax Expense (Benefit)	\$23,001,000	us-gaap:IncomeTaxExpenseBenefit
47	Net Income (Loss)	\$54,358,000	us-gaap:NetIncomeLoss
48	<i>Earnings Per Share [Abstract]</i>		us-gaap:EarningsPerShareAbstract
49	Earnings Per Share, Basic	2.05	us-gaap:EarningsPerShareBasic
50	Earnings Per Share, Diluted	2.03	us-gaap:EarningsPerShareDiluted
51	Common Stock, Dividends, Per Share, Declared	1.07	us-gaap:CommonStockDividendsPerShareDeclared
52			

By contrast, in Figure 57 the preparer has left the published taxonomy element standard label unchanged, focusing instead on the data points, and providing a [negating label](#) so that the value that appears in the raw, unprocessed instance has a “sign flip” applied before it appears in the spreadsheet. Furthermore, the preparer chose to highlight the custom labels with the suffix “(N)” to indicate to the reader that the value as shown in the spreadsheet is the negative of the value stored in the instance.

Figure 57 Element Standard Labels Left Mostly Unchanged

3	Period Start Date - End Date	1/1/2004 - 12/31/2004	XBRL Field
7	Net Income (Loss) [Abstract]		us-gaap:NetIncomeLossAbstract
8	Income (Loss) from Continuing Operations [Abstract]		us-gaap:IncomeLossFromContinuingOperations
9	Income (Loss) from Continuing Operations before Income Method Investments [Abstract]		us-gaap:IncomeLossFromContinuingOperations
10	Revenues [Abstract]		us-gaap:RevenuesAbstract
11	Revenue from Lease or Rental of Property or Equipment	\$119,663,000	us-gaap:RevenueFromLeaseOrRentalOfProperty
12	Sales Revenue, Services, Gross	\$4,885,000	us-gaap:SalesRevenueServicesGross
13	Tenant Reimbursements	\$5,429,000	us-gaap:TenantReimbursements
14	Revenues	\$129,977,000	us-gaap:Revenues
15	Depreciation and Amortization (N)	-\$34,017,000	us-gaap:DepreciationAndAmortization
16	Cost of Other Property Operating Expense (N)	-\$8,973,000	us-gaap:CostOfOtherPropertyOperatingExpense
17	Selling, General and Administrative Expense (N)	-\$13,832,000	us-gaap:SellingGeneralAndAdministrativeExpense
18	Impairment of Investments (N)		us-gaap:ImpairmentOfInvestments
19	Other Nonoperating Income (Expense)	\$3,269,000	us-gaap:OtherNonoperatingIncomeExpense
20	Interest Expense, Debt (N)	-\$42,456,000	us-gaap:InterestExpenseDebt
21	Gains (Losses) on Extinguishment of Debt	-\$56,000	us-gaap:GainsLossesOnExtinguishmentOfDebt
22	Provision for Doubtful Accounts (N)	-\$2,884,000	us-gaap:ProvisionForDoubtfulAccounts
23	Income (Loss) from Continuing Operations before Income Tax Expense (Benefit) (N)	\$31,028,000	us-gaap:IncomeLossFromContinuingOperations
24	Income Tax Expense (Benefit) (N)	-\$1,181,000	us-gaap:IncomeTaxExpenseBenefit
25	Minority Interest in Net Income (Loss) of Consolidated Entity	-\$2,465,000	us-gaap:MinorityInterestInNetIncomeLossOfConsolidatedEntity
26	Income (Loss) from Equity Method Investments	\$7,194,000	us-gaap:IncomeLossFromEquityMethodInvestments
27	Income (Loss) from Continuing Operations	\$34,576,000	us-gaap:IncomeLossFromContinuingOperations
28	Income (Loss) from Discontinued Operations, Net of Tax [Abstract]		us-gaap:IncomeLossFromDiscontinuedOperations
29	Discontinued Operation, Income (Loss) from Discontinued Operations	\$10,203,000	us-gaap:DiscontinuedOperationIncomeLossFromDiscontinuedOperations
30	Discontinued Operation, Gains (Losses) on Extinguishment of Long-Lived Assets to be Disposed of (N)		lxp:DiscontinuedOperationGainsLossesOnExtinguishmentOfLongLivedAssetsToBeDisposedOf
31	Impairment of Long-Lived Assets to be Disposed of (N)	-\$5,447,000	us-gaap:ImpairmentOfLongLivedAssetsToBeDisposedOf
32	Discontinued Operation, Gain (Loss) on Disposal of Discontinued Operation	\$5,475,000	us-gaap:DiscontinuedOperationGainLossOnDisposalOfDiscontinuedOperation
33	Income (Loss) from Discontinued Operations, Net of Tax	\$10,231,000	us-gaap:IncomeLossFromDiscontinuedOperations
34	Net Income (Loss)	\$44,807,000	us-gaap:NetIncomeLoss
35	Redeemable Preferred Stock Dividends (N)	-\$6,360,000	us-gaap:RedeemablePreferredStockDividends

If preparers find elements in the published taxonomy that represent the appropriate financial reporting concepts through review of element definitions, references and other attributes, at most they should add a standard label that uses a more accurate phrase, such as "Furniture and Equipment Expense" instead of "Equipment Expense", so that a user comparing the instance document to the printed financial statements will more easily find the corresponding element.

Rule of Thumb: Changing the labels of an element in the financial statements is permitted, but not required. Before changing labels, ensure that the element represents the appropriate financial reporting concept. 

Finally, an extension may add new types of labels for elements in the XBRL US GAAP Taxonomy. For example, if the taxonomy element does not have a "beginning" or "end" of period label type, but preparers must distinguish the beginning value from the ending value in the disclosure, they can add both "period start" and "period end" label types. In the XBRL US GAAP Taxonomy, these label types are always the same as the standard label, suffixed by the phrase "Beginning of Period" and "End of Period" respectively, and preparers should follow the same convention.

Rule of Thumb: Changing the labels of an element in the XBRL US GAAP Taxonomy is permitted. Follow the style conventions of similar elements already in the XBRL US GAAP Taxonomy. 

The table below interprets error or warning messages about labels, definitions and references that preparers may encounter while editing an extension taxonomy.

Figure 58 Extension Taxonomy Validation Messages about Labels and References

Severity	Key Message Phrases	Solution
Error	"Cannot prohibit arc" "bad fragment identifier"	The extension is attempting to change a definition or a reference. Locate the element named in the error message and revert any attempted changes. Some software products make this impossible to repair, necessitating contact with the software vendor to resolve the error; in that case, avoid problems by taking extreme care to not edit the definition or references in any way.
Warning	"non-ASCII" characters, extra "whitespace"	Labels should never start or end with spaces or carriage returns, and should use only the simplest of formatting. A foolproof, though tedious, method to fix this error (if the software does not fix it automatically) is to copy the label, paste it into a simple text editor such as Windows Notepad, and copy and paste it back into the extension from the text editor.
Warning	Multiple languages in label linkbase	Every label has a language setting. Check to see that all labels have the language "English (United States)" or "en-US", and not simply "English" or "en". This setting exists because XBRL must accommodate financial reporting in countries with more than one official language (Canada, Belgium).

6.6 Method 6: Add a New Relationship between Elements

The most efficient method of constructing an extension for an entire financial statement is to work mainly within the extension's relationship groups (see Figure 46, "Suggested New Relationship Groups") and build up statements and disclosures in the following order:

1. Add calculation relationships into statements.
2. Add dimensional relationships into statements.
3. Add presentation relationships into statements.
4. Add presentation relationships into notes.
5. Add dimensional relationships into notes.
6. Add calculation relationships into notes.

Statements are done in one order (Calculation, Dimensional, and Presentation) and disclosures in the opposite order (Presentation, Dimensional, Calculation) because of the different mix of elements and relationships in the different relationship groups, and the impact of decisions in one area upon decisions in another.

6.6.1 Add Calculation Relationships into Statements

All of the statements in the XBRL US GAAP Taxonomy include calculation relationships, which are explained in detail in [Section 4, Using Taxonomy Calculations](#). These calculations use many more elements than are typically used in a financial statement. Accordingly, elements will need to be removed from the calculation relationships. An effective technique to ensure that preparers include only the calculations that they need in the statements is to start with the source financial statements and a new relationship group in the extension for each statement, work top to bottom through the line items, and copy and paste the elements one at a time from the XBRL US GAAP Taxonomy into the new relationship group. A similar technique is to copy a series of related elements from the published taxonomy, paste them into the new relationship group, and then remove any unnecessary calculation relationships.

Preparers must choose appropriate elements from the XBRL US GAAP Taxonomy to copy and paste into the new calculation relationship group (as discussed in [Section 3, Understanding and Using Taxonomies](#)). The calculations that result from pasting elements into the calculation group may not match the calculations in the financial statements if an element participates in a calculation in the XBRL US GAAP Taxonomy differently than it participates in calculations in the financial statements.

Following two suggestions will help: (1) If the children of a subtotal in the published taxonomy are not presented in the financial statements, do not include the children in the relationship group; (2) If the children are presented as separate line items apart from the subtotal in the base taxonomy, reconstruct the calculations in the extension taxonomy. Figure 59 illustrates this in the income statement of a commercial company.

Figure 59 Moving an Element Out of a Subtotal

XBRL US GAAP Taxonomy Calculation Relationships	Definition
Nonoperating Income (Expense)	The aggregate amount of income (expense) from ancillary business-related activities (that is to say, excluding major activities considered part of the normal operations of the business).
+ Investment Income, Nonoperating	
+ ...	
+ ...	
+ Leveraged Lease Income (Loss)	Amount of net income (loss) composed of: (1) pretax lease income (or loss), (2) investment tax credit, allocated proportionately between unearned and deferred income included in the net investment, and (3) the tax effect of the pretax lease income (or loss) recognized, which shall be reflected in tax expense for the year.
+ ...	
+ Other Nonoperating Income (Expense)	
(As Reported)	
... <i>other income line items</i> ...	
Leveraged Lease Income	\$ 45
Nonoperating Income	132

In the Commercial and Industrial [entry point](#), “Leveraged Lease Income (Loss)” is a descendant of “Nonoperating Income (Expense)”. If leveraged leases are not part of the normal business of the reporting entity and any income from leveraged leases is reported as nonoperating income, then the reporting entity can use this portion of the taxonomy as is, because it includes leveraged lease income as a descendant of other operating income for calculation purposes.

However, if an entity reports Leveraged Lease Income as a line item *at the same level* as, and thus *not* participating in the calculations that add up to, Nonoperating Income (Expense), then since the definition for this element in the XBRL US GAAP Taxonomy does not define it as nonoperating income, preparers should use the “Leveraged Lease Income (Loss)” element but *not* use the calculation relationships that include it as a component of nonoperating income.

As a result, in the newly created Income Statement relationship group for this reporting entity, Leveraged Lease Income and Nonoperating Income will be siblings of the same parent (presumably, Net Income before Income Taxes).

Similar to financial statements, the XBRL US GAAP Taxonomy includes elements that participate both in statements and disclosures. In certain situations an element may be presented in the statements but not in the notes for an entity, or conversely, in the notes but not in the statements.

Figure 60 illustrates a company that reports “Dividends Payable” as a line item on its Balance Sheet. The concept “Dividends Payable” exists in the taxonomy and can be found in the disclosure Accounts Payable and Accrued Liabilities, but not the Balance Sheet. The location of an element in a statement or disclosure section is not meaningful when determining whether it is the appropriate element to use. Preparers should use the element if it represents the appropriate financial concept regardless of whether it exists in the statements or disclosures sections of the taxonomy.

Rule: Use an element from the XBRL US GAAP Taxonomy if it represents the appropriate financial concept regardless of whether it is presented in the statements or disclosures relationship groups.



Figure 60 Using a Concept from a Disclosure

Calculations, As Reported		
Liabilities, Current		
+ Long-term Debt and Capital Lease Obligations, Current	\$	120
+ Accounts Payable		115
+ Accrued Liabilities		232
+ Dividends Payable	>>>>	95
+ Taxes Payable		45
+ Liabilities of Disposal Group, Including Discontinued Operation, Current		8

**Calculation Relationships in the
Statement of Financial Position Relationship Group
of XBRL US GAAP Taxonomy**

Liabilities, Current	
+ Accounts Payable and Accrued Liabilities	
+ Accounts Payable	
+ Accrued Liabilities	
+ Employee-related Liabilities	
+ Taxes Payable	
+ Interest and Dividends Payable	

**Calculation Relationships in Relationship Group
"40000 – Disclosure – Payables and Accruals"
of XBRL US GAAP Taxonomy**

Accounts Payable and Accrued Liabilities	
+ Accounts Payable	
+ Accrued Liabilities	
+ Employee-related Liabilities	
+ Taxes Payable	
+ Interest and Dividends Payable	
+ Dividends Payable	<<<<<
+ Interest Payable	

In Figure 60, the reporting entity should copy the "Dividends Payable" element from the disclosure section of the taxonomy and paste it into its newly created Statement of Financial Position relationship group. The calculation relationships associated with the element in the XBRL US GAAP Taxonomy relate to the disclosure and not the entity's presentation on its Statement of Financial Position, so the existing calculation relationships should be discarded and new ones established.

Figure 61 illustrates a portion of the XBRL US GAAP Taxonomy commercial and industrial cash flow statement relationship group. The signs of the calculation relationships are +1 and -1. "Increase (Decrease) in Operating Capital" has a negative weight relative to the total adjustments. Therefore, if any of its calculation descendants, such as "Increase (Decrease) in Receivables", are promoted up to be a child of "Net Cash Provided by (Used in) Operating Activities", then the calculation weight of that promoted child must also be -1.

The balance type assignment of each element is shown in the rightmost column of Figure 61. The element "Increase (Decrease) in Receivables" has a credit balance, so a positive value indicates an increase in receivables. This is not the sign convention normally presented on a cash flow statement. Any sign flip needed for presentation is done by setting the preferred label of presentation relationships to use a negated label type, as described in [Section 6.3](#).

The result is shown in the bottom part of Figure 61. The "As Reported" presentation relationships show the usual accounting presentation convention. The calculation relationship between "Net Cash Provided by (Used in) Operating Activities" and its child "Increase (Decrease) in Receivables" has a weight of -1.

Figure 61 Moving an Element Out of a Subtotal Involving Negative Weights

Calculation Relationships from Statement in the XBRL US GAAP Taxonomy		Balance
Net Cash Provided by (Used in) Operating Activities, Continuing Operations		(none)
+1	Income (Loss) from Continuing Operations	credit
	+1 Income (Loss) from Continuing Operations	credit
	-1 Adjustments to Reconcile to Income (Loss) from Continuing Operations	(none)
+1	Adjustments to Reconcile Income (Loss) to Net Cash Provided by (Used in) Continuing Operations	debit
	+1 Adjustments for Noncash Items Included in Income (loss) from Continuing Operations	(none)
>>>>>>>>	-1 Increase (Decrease) in Operating Capital <<<<<<<<<	credit
	+1 Increase (Decrease) in Operating Assets	credit
	+1 Increase (Decrease) in Receivables	credit

As Reported (Presentation Relationships)		Calculation Relationships	
Net Cash Provided by (Used in) Operating Activities [Abstract]		Net Cash Provided by (Used in) Operating Activities	
Net Income (Loss)	255	+1 Net Income (Loss)	255
(Increase) Decrease in Receivables	(15)	-1 Increase (Decrease) in Receivables	15
Net Cash Provided by (Used in) Operating Activities, Total	240		

Generally, preparers should use calculations because they help to check the extension taxonomy design and the accuracy of data in the instance document, not only in the current period but in each subsequent period when preparers create new instance documents.

However, not all of the amounts on a statement actually appear in a calculation. For example:

- Elements representing beginning or end of period balances (“instant” period type) never appear in a calculation with elements representing measurements over a “duration” period type; therefore a calculation relationship group will never contain a roll-forward calculation.
- Cash Flow Statement supplementary line items, such as cash paid for taxes, do not appear in calculations.
- Parenthetical items on a statement, such as number of shares outstanding in a balance sheet, do not appear in its calculations.

Preparers may add presentation relationships to the extension taxonomy for these elements, as described in [Section 6.6.3](#). Starting with calculations helps check the calculation consistency of the extension taxonomy and ultimately will help to ensure that the right values in the instance document are tagged with appropriate elements.

The ordering of calculation relationships, including the order that the top level elements appear, has no impact on the calculations. Therefore, few software products allow the user to control the order in which top level elements appear within a calculation group.

The table below interprets error or warning messages about calculation relationships that preparers may encounter while editing an extension taxonomy.

Figure 62 Extension Taxonomy Validation Messages about Calculations

Severity	Key Message Phrases	Solution
Error	Disagreement between calculation weight and balance attribute of parent and child	For any calculation parent with a balance of "credit" or "debit", for any of its children with balances of "credit" or "debit", there is no choice as to what the weight on the calculation relationship will be. See Figure 33 for the rule. Flip the sign of the weight on the calculation relationship causing the error.
Error	Non-numeric element type	The parent and child of a calculation relationship must both be numeric. Therefore they cannot be strings, text blocks, domains, domain member, axes, or tables.
Warning	Inconsistent element types	Within numeric types, the elements must be compatible: monetary to monetary, per share to per share, and so forth.
Warning	Abstract element	A calculation relationship with either parent or child as an abstract element has no effect; more generally, an abstract element should never be a numeric type.
Warning	Inconsistent Period Types	Elements in a calculation have different period types (instance or duration). XBRL calculations do not work across different period types. To address, remove the calculation relationship.
Warning	Cycle or Loop	An element either appears as a descendant of itself, or two elements both share two of the same parents. Correct the calculations in the extensions to remove the warning. If the software product reports an <i>error</i> rather than a warning, the product is using an outdated XBRL specification.
Warning	Multiple Children	An element appears more than once as a calculation child of the same parent element. This may be a symptom that the financial statement mapping erroneously had distinct line items mapped to the same element. Check the original mapping and remove all but one of the relationships.
Warning	Multiple Parent	An element with more than one parent exists in the same relationship group, which is rarely intentional. To address, divide the calculations into alternate groups. See Figure 31, "Deposits Example, Presentation and Calculation Relationships".

6.6.2 Add Dimensional Relationships into Statements

Each statement [relationship group](#) in the XBRL US GAAP Taxonomy has exactly one "Statement [Table]" element and its dimensional relationships. The statement table has one axis (scenario) that has a domain ("Scenario, Unspecified [Domain]"), and it applies to all line items in the statement.

For most instance documents, preparers do not need to do anything to have the default scenario applied to all of the tags in all statements. Preparers need to use dimensional relationships only in the following cases:

1. **Restated Amounts:** An entity reports amounts in its statements that have been restated from a prior period.
2. **Multiple Reports:** An entity reports more than one occurrence of the statement for the same period and entity, distinguished in some way such as "actual" versus "plan" or "forecast".
3. **Multiple Entities:** A single statement includes more than one entity (for example, a parent entity, major subsidiaries, eliminations, and consolidated amounts).
4. **Multiple Stock Classes:** The equity section of a statement of financial position is segregated by different classes of stock.
5. **Multiple Equity Components:** A statement of changes in shareholders' equity in which there are changes to multiple components of equity can use tables to organize the information.

In these cases, preparers should add dimensional relationships into the relationship groups of the extension taxonomy (see Figure 46, "Suggested New Relationship Groups") to reflect the multiple reports, entities, or stock classes of the entity and its statements. The elements to use for the domain

members are found in the relationship group “190000 – Statement – Common Domain Members” and should be used before creating new elements. Figure 63 shows the elements and relationships in group 190000.

Figure 63 Common Domain Members (Dimensional Relationships)

Statement [Table]
Statement, Scenario [Axis]
Scenario, Unspecified [Domain]
Scenario, Actual [Member]
Scenario, Adjustment [Member]
Scenario, Forecast [Member]
Scenario, Plan [Member]
Scenario, Previously Reported [Member]
Statement, Operating Activities Segment [Axis]
Segment, Operating Activities [Domain]
Segment, Continuing Operations [Member]
Segment, Discontinued Operations [Member]
Statement, Business Segments [Axis]
Segment, Business [Domain]
Business Intersegment, Eliminations [Member]
Statement, Business Segments [Axis]
Segment, Geographical Segments [Domain]
Geographical Intersegment, Eliminations [Member]
Legal Entity [Axis]
Entity [Domain]
Parent Company [Member]
Subsidiaries [Member]
Guarantor Subsidiaries [Member]
Non-Guarantor Subsidiaries [Member]
Consolidation, Eliminations [Member]
Majority-Owned Entity, Unconsolidated [Member]
...
Corporate Joint Venture [Member]
Partnership Interest [Member]
Statement, Class of Stock [Axis]
Class of Stock [Domain]
Common Class A [Member]
Common Class B [Member]
...

To describe the situations outlined above, the example in Figure 64 uses the relationship group “104000 – Statement – Statement of Financial Position, Classified”.

Figure 64 Statement of Financial Position, Classified (Dimensional Relationships)

Statement [Line Items]
Statement [Table]
Statement, Scenario [Axis]
Scenario, Unspecified [Domain]
Assets [Abstract]
Assets, Current [Abstract]
Assets, Noncurrent [Abstract]
Assets
Liabilities and Stockholders' Equity [Abstract]
...
Liabilities and Stockholders' Equity

Restatements and Adjustments in Statements

An extension taxonomy can define any number of related statements for a given entity and period.

For example, in Figure 65 the extension taxonomy has relationships allowing balance sheets that distinguish between restated data, the amounts previously reported for the same periods, and the adjustment.

Figure 65 Fragment Containing Previously Reported, Adjusting, and Restated Data

(in millions)	FY13		FY13	FY12		FY12
	Previously Reported	Adjustment		Previously Reported	Adjustment	
Statement [Line Items]						
Assets [Abstract]						
Assets, Current	949	(19)	930	924	(3)	921
Assets, Noncurrent	1,070		1,070	1,046		1,046

Figure 66 illustrates how to use the scenario axis to distinguish the different amounts. The “Scenario Adjustment [Member]” and “Scenario, Previously Reported [Member]” domain members distinguish between the adjusted or previously reported amounts and the restated values, which are the values reported without any further qualification.

Figure 66 Statement (Dimensional Relationships)

	New Relationship
Statement [Line Items]	
Statement [Table]	
Statement, Scenario [Axis]	
Scenario, Unspecified [Domain]	
Scenario, Adjustment [Member]	Domain-Member
Scenario, Previously Reported [Member]	Domain-Member
...	
Assets [Abstract]	
Assets, Current	
Assets, Noncurrent	
...	

In practice, the default scenario is normally used to the same effect as “actual”. To identify amounts as “restated”, preparers use an XBRL footnote and include “restated” in the text of the footnote. There should be no separate domain member for “restated” amounts.

Rule: Use an XBRL footnote with “restated” in the text of the footnote to identify amounts in an instance document as restated.



Refer to Section 7.8 for additional information on XBRL footnotes.

Multiple Reports

An extension taxonomy can define any number of related statements for a given entity and period. In Figure 67, the extension taxonomy has relationships allowing balance sheets that distinguish between historical (“actual”) data and the amounts originally planned for the same periods. The scenario axis is used to distinguish these different reports.

Figure 67 Balance Sheet Fragment Containing Historical and Planned Data

(in thousands)	Scenario, Actual		Scenario, Plan	
	[Member]		[Member]	
	FY13	FY12	FY13	FY12
Statement [Line Items]				
Assets [Abstract]				
Assets, Current [Abstract]				
Assets, Current	204	192	312	172
...

Although the default scenario is normally used to the same effect as “actual”, this situation is different because there are two entirely distinct balance sheets, rather than just one or a few line items reported. To choose the appropriate domain member elements to distinguish the two amounts, preparers should use the same principles employed to select any other element from the XBRL US GAAP Taxonomy.

Rule of Thumb: If reports will contain two or more full statements with the same elements, distinguish the statements using distinct scenario members. Otherwise, continue using the default “Scenario, Unspecified [Domain]”. 

In the relationship group created for the balance sheet, a preparer would start with a copy of the relationships in Statement 104000, then add the two relationships shown bold in Figure 68. This adds two domain members to the existing scenario domain in the statement.

Figure 68 Multiple Reports of the Same Statement (Dimensional Relationships)

	New Relationship
Statement [Line Items]	
Statement [Table]	
Statement, Scenario [Axis]	
Scenario, Unspecified [Domain]	
Scenario, Actual [Member]	Domain-Member
Scenario, Plan [Member]	Domain-Member
Assets [Abstract]	
Assets, Current [Abstract]	
...	
Inventory, Net	
...	

It is important to verify that the relationships are exactly as shown in the rightmost column, even if the software automates creation of these relationships. If the software has a feature that previews table layouts from dimensional relationships, a preparer should use it to verify that the dimensional relationships can recreate the desired layout (in this case Figure 67).

Multiple Entities

The example in Figure 69 represents an entity with a major subsidiary. Instead of two columns of data in the balance sheet (current and prior year), such an entity might show three pairs of columns: the consolidated entity, the parent entity, and the subsidiary.

Figure 69 Balance Sheet Fragment with Multiple Entities

(in millions)	Entity [Domain]		Parent Company [Member]		Subsidiaries [Member]	
	FY13	FY12	FY13	FY12	FY13	FY12
Statement [Line Items]						
Assets [Abstract]						
Assets, Total	662	673	188	189	528	540
Liabilities and Stockholders' Equity [Abstract]						

To choose the appropriate elements for the columns, the principle applied is the same as for choosing any other element. The Common Domain Members relationship group contains elements to represent the entire entity (“Segment, Consolidated [Domain]”) and the parent and subsidiary have appropriate definitions, so there is no need to create new elements.

Rule: Do not create an explicit “total” domain member for any domain; the domain element itself represents the total. 

In the relationship group created for the balance sheet in this example, a preparer would start with a copy of the relationships from Statement 104000 of the XBRL US GAAP Taxonomy, then add the relationships shown bold in

Figure 70. This adds a new axis to the statement table, using the domain members referred to in the statements.

Figure 70 Multiple Entities (Dimensional Relationships)

	New Relationship
Statement [Line Items]	
Statement [Table]	
...	
Entities, Entity [Axis]	Table-Axis
Entity [Domain]	Axis-Domain
Parent Company [Member]	Domain-Member
Subsidiaries [Member]	Domain-Member
Entity [Domain]	Axis-Default
...	
Assets [Abstract]	
Assets, Current [Abstract]	
Assets, Noncurrent [Abstract]	
Assets	
Liabilities and Stockholders' Equity [Abstract]	
...	
Liabilities and Stockholders' Equity	

It is important to verify that the relationships between specific elements are the ones shown in the rightmost column. Even if the software automates creation of these relationships, a preparer should verify that all and only these relationships are present. If the software has a feature that previews table layouts from dimensional relationships, a preparer should use it to verify that the dimensional relationships can recreate a layout like that in Figure 69.

Multiple Stock Classes

Figure 71 represents an entity with multiple common stock classes disclosed on its balance sheet. Relationship Group 104000, the statement of financial position, does not include distinct elements for the value, number of shares, and other concepts for every class of common stock. Adding the stock class relationships to the balance sheet requires no new elements to be created. The Common Domain Members relationship group contains elements to represent the classes of stock.

Figure 71 Balance Sheet Fragment with Multiple Stock Classes

(in millions)		2013	2012
Statement [Line Items]			
Stockholders' Equity [Abstract]			
Nonredeemable Preferred Stock, Value		43	14
Common Stock, Value	Common Class A [Member]	97	88
	Common Class B [Member]	18	17
	Nonvoting Common Stock [Member]	8	7

In the relationship group created for the balance sheet, a preparer would start with a copy of the relationships from Statement 104000 of the XBRL US GAAP Taxonomy, then add the relationships shown bold in Figure 72. This adds a new axis to the statement table, using just the domain members referred to in the statements.

Figure 72 Multiple Stock Classes (Dimensional Relationships)

	New Relationship
Statement [Line Items]	
Statement [Table]	
...	
Statement, Class of Stock [Axis]	Table-Axis
Class of Stock [Domain]	Axis-Domain
Common Class A [Member]	Domain-Member
Common Class B [Member]	Domain-Member
Nonvoting Common Stock [Member]	Domain-Member
Class of Stock [Domain]	Axis-Default
Assets [Abstract]	
...	
Liabilities and Stockholders' Equity [Abstract]	
...	
Stockholders' Equity [Abstract]	

It is important to verify that all and only these new relationships appear, and particularly that there are *two* relationships from the "Statement, Class of Stock [Axis]" to "Class of Stock [Domain]": the axis-domain relationship and the axis-default relationship. Without both relationships, validation errors will appear now or later. If the software has a feature that previews table layouts from dimensional relationships, a preparer should use it to verify that the dimensional relationships can recreate a layout like Figure 71.

Multiple Equity Components

The XBRL US GAAP Taxonomy Statement of Equity is a table with line items containing seven roll-forwards. The roll-forwards contain the line items for balances and changes in issued and treasury stock, retained earnings, and accumulated other comprehensive income. The statement also has three axes: Scenario, Class of Stock, and Equity Components. Scenario and Class of Stock were described earlier. "Statement, Equity Components [Axis]" has the domain "Equity Component [Domain]"; companies with simple capital structures will usually have no need to use this axis.

There are about twenty domain members arranged in a hierarchy as children and descendants of element "Equity Component [Domain]". The domain members allow the preparer to differentiate the impact of line items such as "Stock Issued During Period, Value, Acquisitions", including their separate impact on, for example, "Common Stock [Member]" and "Common Stock Including Additional Paid in Capital [Member]". Figure 73 shows an actual statement of equity organized in this way.

Figure 73 Statement of Equity Example, with Components of Equity

(in millions)	Preferred Stock [Member]	Common Stock [Member]	Additional Paid-in Capital [Member]	Treasury Stock [Member]	Retained Earnings [Member]	Accumulated Net Unrealized Investment Gain (Loss) [Member]	Accumulated Translation Adjustment [Member]	Accumulated Defined Benefit Plans Adjustment [Member]	Equity Component [Domain]
Increase (Decrease) in Stockholders' Equity [Roll-Forward]									
Stockholders' Equity, Beginning Balance	1	8	17,274	(959)	10,865	1,942	11	(41)	29,101
Treasury Stock Transaction, Value, Net			(180)	398					218
Dividends, Preferred Stock					134				134
Dividends, Common Stock					450				450
Net Income					6,293				6,293
Other Comprehensive Income, Unrealized Gain (Loss) on Derivatives Arising During Period, Net of Tax						(43)			(43)
Other Comprehensive Income, Reclassification Adjustment on Derivatives Included in Net Income, Net of Tax						(35)			(35)
Other Comprehensive Income, Foreign Currency Transaction and Translation Adjustment, Net of Tax, Period Increase (Decrease)							46		46
Other Comprehensive Income, Minimum Pension Liability Net Adjustment, Net of Tax								(18)	(18)
Other Comprehensive Income (Loss), Net of Tax, Period Increase (Decrease), Total									(50)
Comprehensive Income, Net of Tax, Total									6,243
Cumulative Effect of Initial Adoption of SFAS 158								744	744
Stockholders' Equity, End of Period	1	8	17,454	1,357	16,574	1,864	57	(803)	33,798

As with other tables, the only calculation relationships that are relevant and would be copied into the company's extension would be those in the line items shown in the figure as a vertical axis.

The table below interprets error or warning messages about dimensional relationships that preparers may encounter while editing an extension taxonomy.

Figure 74 Validation Messages about Dimensional Relationships

Severity	Message Key Phrases	Solution
Error	Source or Target is not the right element type, or is not the right substitution group.	There are several distinct dimensional relationships, including Table-Axis , Axis-Domain , Domain-Member and others. The relationship name generally follows the "parent-child" pattern. The parent of a Table-Axis relationship must be a table and the child an axis; the parent of the Axis-Domain relationship must be an axis, and its child a domain. Check that each element has the correct substitution group.
Error	Target of a dimension-default relationship is not a member.	Check to see that the axis element has two relationships with its domain element child: one specifies that it is the domain of the axis; the other specifies that it is the default.
Error	More than one default member; the axis specifies more than one default.	A single axis element cannot be a parent in more than one "dimension-default" relationship; check to see that each axis appears only once anywhere in the dimensional relationships of the <i>entire</i> extension and XBRL US GAAP Taxonomy combined.
Error	Target role does not exist; context element not recognized.	There are errors in the technical attributes that should be automatically assigned by software (target role should be blank; context element should always be "segment"). Following the procedures described in this section will avoid problems of this type. If these errors occur, the safest approach is to delete each relationship causing an error and start over.
Error	Duplicate or repeated axis	Make sure that each axis appears only once as a child of the table element. It is possible to have axes that share domain members, but not to have the same axis repeated in the same table.
Warning	Duplicate or repeated domain member	Make sure that each domain element or domain member element appears only once as a descendant of the axis element. This is technically valid but almost always unintentional.

The terminology used in the XBRL US GAAP Taxonomy for tables and dimensional relationships differs somewhat from the underlying technical XBRL terms. To interpret error messages or solve other problems, preparers may need to refer to the underlying technical terminology as shown in Figure 75. In most cases, however, it is not necessary for a preparer to be familiar with this terminology.

Figure 75 Technical Details of Parent-Child Structure in Tables (Dimensional Relationships)

Table Element	Relationship Type	Period Type	Data Type	Abstract	Substitution Group
[Line Items]		Duration	String	Yes	Item
Hypercube	All	Duration	String	Yes	hypercubeItem
Dimension	hypercube-dimension	Duration	String	Yes	dimensionItem
Domain	dimension-domain	Duration	domainItemType	No	item
Domain Member 1	domain-member	Duration	domainItemType	No	item
Domain Member 2	domain-member	Duration	domainItemType	No	item
Domain Member ...	domain-member	Duration	domainItemType	No	item
Domain	dimension-default	Duration	domainItemType	No	item
Domain Member 1	domain-member	Duration	domainItemType	No	item
Domain Member 2	domain-member	Duration	domainItemType	No	item
Domain Member ...	domain-member	Duration	domainItemType	No	item
Line Item 1	domain-member	(Either)	(Any)	(Either)	item
Line Item 2	domain-member	(Either)	(Any)	(Either)	item
Line Item ...	domain-member	(Either)	(Any)	(Either)	item

6.6.3 Add Presentation Relationships into Statements

The relationship groups of the extension (Figure 46, "Suggested New Relationship Groups") are a blank slate where preparers create presentation relationships between elements to reflect the desired ordering and nesting of line items in statements. An effective procedure for creating the presentation relationships follows:

1. Choose a single abstract element to place at the top of the statement.
2. Copy the elements from calculation relationships already created into presentation relationships.
3. Add the other elements that appear as line items but are not in the calculations into the presentation relationships.
4. Add each parenthetical disclosure as a child of the line item to which it applies.
5. Assign preferred labels relationships for line items representing totals, beginning, and ending balances.
6. If any dimensional relationships are relevant to the statement, then align the table, axis, domain, member, and line items in the same way as the XBRL US GAAP Taxonomy.

If validation errors occur while adding presentation relationships, consult Figure 49.

1. Place an abstract element at the top of the statement

The first step in creating presentation relationships is to choose one abstract element from the XBRL US GAAP Taxonomy, as shown in Figure 76, and make it the topmost element in the corresponding relationship group of the extension.

Figure 76 Topmost Elements for the Presentation Relationship Groups

Statement of Financial Position [Abstract]
Income Statement [Abstract]
Statement of Income and Comprehensive Income [Abstract]
Statement of Stockholders' Equity [Abstract]
Statement of Partners' Capital [Abstract]
Statement of Cash Flows [Abstract]
Operating Cash Flows, Direct Method [Abstract]

2. Copy calculation relationships – Case 1

Calculation relationships, created in an earlier step, should be reflected in the presentation relationships. However this is accomplished, preparers must avoid discrepancies between the elements

in the presentation and the calculation. The procedures in this subsection help to ensure that the presentation and calculation relationships are consistent.

Rule: Verify that every element appearing in the calculations appears in the presentation relationships of the corresponding relationship group.



Figure 77 illustrates the relationship between calculation relationships and presentation relationships that exists in the XBRL US GAAP Taxonomy. For most of the line items in balance sheets and cash flow statements, extension taxonomies can follow this pattern without difficulty.

Figure 77 Presentation vs. Calculation Relationships (Balance Sheet) ABC Company and Subsidiaries

Presentation Relationships		Calculation Relationships	
Assets, Current [Abstract]	Parent	Assets, Current	Parent (Summation)
Cash, Cash Equivalents, and Short-term Investments	Child	Cash, Cash Equivalents, and Short-term Investments	Child (Item)
Marketable Securities, Current	Child	Marketable Securities, Current	Child (Item)
Receivables, Net	Child	Receivable, Net	Child (Item)
Inventories, Net	Child	Inventories, Net	Child (Item)
Deferred Tax Assets, Net, Current	Child	Deferred Tax Assets, Net, Current	Child (Item)
Other Assets, Current	Child	Other Assets, Current	Child (Item)
Assets, Current, Total	Child		

Although software may support more automated methods for creating presentation relationships from the calculation relationships, the basic method below works for balance sheets and cash flows:

1. Start with the topmost elements in the calculation (“Assets, Current” in Figure 77).
2. For each element that has calculation children, find or create an abstract element with the same standard label followed by the suffix “[Abstract]”, and paste it into the presentation relationship group in an appropriate place underneath the topmost abstract element in the statement.
3. Copy the calculation children of the element, and paste them into the presentation relationships as children of the abstract element. It is best for reusability if the ordering is the same in the calculation and presentation relationships.
4. Copy the element that had the calculation children, and paste it as the last child of the abstract element.
5. Repeat 1 through 4 for any of the calculation children that have children themselves.

Copy calculation relationships – Case 2

Income statements and statements of comprehensive income require a different approach to copying, because the calculation relationships have multilevel netting relationships. For example, Net income is Gross Profit net of Expenses, Gross Profit is Sales net of Cost of Goods sold, and so on. Normally, however, the presentation is not nested in the same way, as illustrated in Figure 78.

Figure 78 Presentation vs. Calculation Relationships (Income Statement, ABC Company and Subsidiaries)

Presentation Relationships		Calculation Relationships	
Income Statement [Abstract]	Parent		
Net Sales	Child	Net Income	Parent (Summation)
Costs of Goods Sold	Child	+ Gross Profit	Child (Item) & Parent
Gross Profit, Total	Child	+ Net Sales	Child (Item)
Selling, General and Administrative Expense	Child	- Cost of Goods Sold	Child (Item)
Other (income) expense	Child	- Selling, General and Administrative Expense	Child (Item)
Interest expense	Child	+ Other Income (Expense)	Child (Item)
Income Tax Benefit	Child	- Interest Expense	Child (Item)
Net Income	Child	- Income Tax Expense	

In cases like this, creating presentation relationships involves these steps:

1. Start with the first element that has no calculation children ("Net Sales" in Figure 78).
2. Paste the element into the next position underneath an abstract element.
3. Move to the next element that has no calculation children. If there are none, stop.
4. Repeat steps 2 and 3 until there is a calculation parent, all of whose children now appear in the presentation relationships.
5. Go to step 2, but start with the calculation parent from step 4.

If the extension taxonomy contains multiple calculation relationship groups for a statement, preparers should start with the main calculation relationship, then repeat the process for each of the alternative calculation relationship groups (see Figure 31, "Deposits Example, Presentation and Calculation Relationships", for details).

3. Add other elements not appearing in calculations

For balance sheets and income statements, once elements are copied from the calculation relationships there are usually few if any elements remaining. Cash flow statements and statements of equity require additional attention, because period beginning and ending balances that do not appear in calculations must nevertheless appear in presentation relationships. Figure 79 illustrates such presentation relationships, using standard labels only. Of the elements shown that are not abstract, only "Cash and Cash Equivalents, Period Increase (Decrease)" appears in the calculation relationships; it is the sum of operating, financing, and investing cash flows.

Figure 79 Presentation Relationships with Standard Labels, Cash Flow Statement for ABC Company and Subsidiaries

Presentation Relationships	No Calculation Relationships
Statement of Cash Flows [Abstract]	
Cash and Cash Equivalents, Period Increase (Decrease) [Abstract]	
...	
...	
Cash and Cash Equivalents, Period Increase (Decrease)	
Cash and Cash Equivalents, at Carrying Value, Beginning Balance	<<<
Cash and Cash Equivalents, at Carrying Value, Ending Balance	<<<
Supplemental Cash Flow Information [Abstract]	
Interest Paid	<<<
Income Taxes Paid	<<<

Similarly, the various beginning and end of period balances appearing in the Statement of Shareholders' Equity do not participate in calculations. Figure 80 shows presentation relationships; again, few of the non-abstract line items are in a calculation.

Figure 80 Statement of Partners' Capital (Selected Presentation Relationships)

Presentation Relationships	No Calculation Relationships
Increase (Decrease) in Accumulated Other Comprehensive Income (Loss), Components, Net of Tax [Abstract]	
Increase (Decrease) in Accumulated Other Comprehensive Income (Loss), Benefit Plans Adjustment, Net of Tax [Roll-Forward]	
Accumulated Other Comprehensive Income (Loss), Defined Benefit Pension and Other Postretirement Plans, Net of Tax, Beginning Balance	<<<
Other Comprehensive Income, Defined Benefit Plans Adjustment, Net of Tax, Period Increase (Decrease)	<<<
Accumulated Other Comprehensive Income (Loss), Defined Benefit Pension and Other Postretirement Plans, Net of Tax, Ending Balance	<<<
Increase (Decrease) in Accumulated Other Comprehensive Income (Loss), Net of Tax [Roll-Forward]	
Accumulated Other Comprehensive Income (Loss), Net of Tax, Beginning Balance	<<<
Other Comprehensive Income (Loss), Net of Tax, Period Increase (Decrease)	<<<
Accumulated Other Comprehensive Income (Loss), Net of Tax, Ending Balance	<<<

Not only are there few elements to copy from the calculation relationships, but the presentation relationships for the Statement of Shareholders' Equity themselves have an unfamiliar layout. Therefore, the best approach is to copy the presentation relationships from relationship group "148630 - Statement - Statement of Shareholders' Equity and Other Comprehensive Income", leaving out roll-forward groups that do not apply and any elements whose value is zero or unreported in any period.

4. Add parenthetical disclosure elements

Parenthetical disclosures contain amounts that must be tagged like any other material disclosures.

Rule: Tag disclosures made parenthetically such as the amounts of "allowance for doubtful accounts" or "shares authorized, issued and outstanding".



Preparers should start from the original financial statements to create the necessary presentation relationships. In mapping the financial statements, each line item containing parenthetical disclosures will map to more than one element. In Figure 81, for example, the single line item shown as "Unrealized holding gains arising during period (net of income taxes of \$317)" maps to two elements: a main element for the amount net of tax, and a secondary element for the amount of tax. More than one secondary element may be needed.

The main item ("Unrealized holding gains arising during period" in Figure 81) appears as a child just where it would have had it not had a parenthetical. However, each of the secondary elements becomes a presentation child of the main element. This is because the secondary elements must appear *somewhere* in the presentation relationships, and cosmetic aspects of the layout are less important than keeping the secondary elements closely tied to their main element.

Figure 81 Statement of Other Comprehensive Income, Presentation Relationships with Parentheticals and Standard Labels, ABC Company and Subsidiaries

ABC Company Layout	Presentation Relationships with Standard Labels
<p>Net income</p> <p style="padding-left: 20px;">Other comprehensive income, net of tax</p> <p style="padding-left: 40px;">Unrealized gains on securities</p> <p style="padding-left: 40px;">Unrealized holding gains arising during period (net of income taxes of \$317)</p> <p style="padding-left: 40px;">Less: reclassification adjustment for gains included in net income (net of income taxes of \$57)</p> <p style="padding-left: 20px;">Comprehensive income</p>	<p>Net Income (Loss)</p> <p style="padding-left: 20px;">Other Comprehensive Income (Loss), Net of Tax, Period Increase (Decrease) [Abstract]</p> <p style="padding-left: 40px;">Other Comprehensive Income, Available-for-Sale Securities Adjustment, Net of Tax, Period Increase (Decrease) [Abstract]</p> <p style="padding-left: 40px;">Other Comprehensive Income, Unrealized Holding Gain (Loss) on Securities Arising During Period, Net of Tax</p> <p style="padding-left: 20px;">>>> Other Comprehensive Income, Unrealized Holding Gain (Loss) on Securities Arising During Period, Tax</p> <p style="padding-left: 40px;">Other Comprehensive Income, Reclassification Adjustment for Sale of Securities Included in Net Income, Net of Tax</p> <p style="padding-left: 20px;">>>> Other Comprehensive Income, Reclassification Adjustment for Sale of Securities Included in Net Income, Tax</p> <p style="padding-left: 40px;">Other Comprehensive Income, Available-for-Sale Securities Adjustment, Net of Tax, Period Increase (Decrease)</p> <p style="padding-left: 20px;">Comprehensive Income, Net of Tax</p>

Not everything inside of parentheses is a parenthetical disclosure. For example, a line item such as "Short-term borrowings (Note 8)" maps to the element "Short-term Borrowings"; the element "Short-term Borrowings" will also appear in the company's Notes to Consolidated Financial Statements, but "(Note 8)" should not be added to the element's standard or other labels. Both the disclosure and the balance sheet already contain the same element, so there is no reason to further indicate the relationships between primary statements and the notes. Besides, "Note 8" this period might be "Note 7" next period, and period-specific information must not be used in a label.

Rule: Do not include period-specific or other information that is likely to change in future periods in the label of an element.



5. Assign preferred labels

Having created a new set of presentation relationships to reflect the order and nesting of elements in each statement, the next step is to assign preferred labels (see [Section 6.3](#)). Preparers should do this on every presentation relationship where the child: (1) is a beginning of period balance; (2) is an end of period balance; (3) is a total of other elements; or (4) has a credit or debit balance attribute giving the element a sign that is the opposite of the desired presentation. The latter requires the use of negated labels.

Figure 82 repeats the bottom half of Figure 61. In this example, the element "Increase (Decrease) in Receivables" is subtracted from "Net Income (Loss)" to arrive at "Net Cash Provided by (Used in) Operating Activities". To achieve the desired effect, a preparer should use this procedure:

1. Ensure that the element "Increase (Decrease) in Receivables" has a label with the type "negated" in addition to its standard label. A clear and unambiguous negated label in this case would be "(Increase) Decrease in Receivables". Simply using "Receivables" or "Change in Receivables" is ambiguous and could lead to incorrect interpretation of the resulting data.
2. For the relationship from "Net Cash Provided by (Used in) Operating Activities, Continuing Operations [Abstract]" to its child element "Increase (Decrease) in Receivables", make its preferred label "negated".

XBRL-enabled software for rendering instances will display the negated label for the line item; if it fully supports negated labels, it will flip the sign of the amounts shown for the line item.

Figure 82 Presentation and Calculation Relationships, Cash Flow Statement of ABC and Subsidiaries

As Reported (Presentation Relationships)		Calculation Relationships	
Net Cash Provided by (Used in) Operating Activities [Abstract]		Net Cash Provided by (Used in) Operating Activities, Continuing Operations	240
Net Income (Loss)	255	+1 Net Income (Loss)	255
(Increase) Decrease in Receivables	(15)	-1 Increase (Decrease) in Receivables	15
Net Cash Provided by (Used in) Operating Activities, Continuing Operations, Total	240		

The preferred label applies *only* to how that element is used in a specific presentation relationship and relationship group. For example, in the Statement of Comprehensive Income (Figure 81), it does not matter that the element "Net Income (Loss)" has calculation children in the Income Statement (Figure 78); it only matters whether it has calculation children in the Statement of Comprehensive Income. Therefore, "Net Income (Loss)" should not have a preferred label type "total" in the Statement of Comprehensive Income.

If validation errors occur while assigning preferred labels, consult Figure 51.

6. Align dimensional and presentation relationships

If the extension taxonomy has new dimensional relationships because of multiple entities, reports, classes of stock, or some other requirement, then all of the presentation relationships created for the statements must also be duplicated in dimensional relationships. If this is not done, the instance document will not validate properly.

As discussed in [Section 4, Using Taxonomy Calculations](#), the XBRL US GAAP Taxonomy has a copy of every dimension relationship in the form of a presentation relationship to facilitate browsing all elements within a single set of relationships. It is helpful to other users of the extension taxonomy to follow this same convention, although it has no impact on the meaning of the elements or layout of tables.

To achieve validation and ease browsing, some software automates this alignment, displays dimensional relationships in a way that hides this detail, or warns the user when the alignment is not correct. Regardless of the software, copying selected elements from the dimensional to the presentation relationships and vice versa is an effective method to achieve alignment, as shown in Figure 83.

Figure 83 Alignment of Dimensional and Presentation Relationships

Dimensional Relationships	Presentation Relationships
Statement [Line Items]	Statement [Table]
Statement [Table]	Statement, Scenario [Axis]
Statement, Scenario [Axis]	Scenario, Unspecified [Domain]
Scenario, Unspecified [Domain]	Scenario, Actual [Member]
Scenario, Actual [Member]	Scenario, ... [Member]
Scenario, ... [Member]	Statement [Line Items]
Assets [Abstract]	Assets [Abstract]
Assets, Current [Abstract]	Assets, Current [Abstract]
...	...
Inventory, Net	Inventory, Net
...	...

The relationship between the "[Line Items]" abstract element and its child line items and their descendants is identical on both sides. Likewise, the relationship between the "[Table]" element and its "[Axis]" children and their descendants is also identical on both sides. The only difference is that the "[Line Items]" is the parent of "[Table]" in the dimensional relationships, and "[Table]" is the parent of "[Line Items]" in the presentation relationships. The "[Line Items]" abstract element in the dimensional relationships is the last child of the "[Table]" element in the presentation relationships; or, equivalently, the "[Table]" element from the presentation relationships is moved to be the first child of the "[Line Items]" element in the dimensional relationships.

Rule: If an extension has dimensional relationships, then all elements in presentation relationships of a statement must also appear in dimensional relationships; otherwise, instance documents will not properly validate.



Rule of Thumb: If an extension has dimensional relationships, then the table, axis, domain, and member elements should be in presentation relationships.



6.6.4 Add Presentation Relationships into Notes

Adding relationships to the extension taxonomy for notes and disclosures of the financial statements begins with presentation relationships. In the relationship groups of the extension (Figure 46, “Suggested New Relationship Groups”), all of the notes and disclosures may be included in a single presentation relationship group. An effective method of adding the presentation relationships follows:

1. Create a single abstract element and place it at the top of the “Notes and Disclosures” relationship group.
2. Map each note in the financial statements to one of the “Text Block” elements from the Disclosure relationship groups in the XBRL US GAAP Taxonomy.
3. Copy the mapped elements from XBRL US GAAP Taxonomy and paste them as children to the top abstract element, in the order that the notes appear in the financial statements.
4. If tagging only at the text block level, stop. If tagging to a finer level of detail, continue to step 5.
5. For each note, and each financial reporting concept in that note, including sections of text and information in tables, map the financial concepts to an element in XBRL US GAAP Taxonomy (financial concepts might still map to text blocks, but they will be more narrowly defined than the text block for the entire disclosure).
6. Copy the mapped elements from the XBRL US GAAP Taxonomy and paste those elements in the order they appear in the financial statements as children of the respective Text Block.

Most of these steps are similar to the steps for creating statements; the following explanations focus mainly on what differs from creating statements. If validation errors occur while adding presentation relationships, consult Figure 49.

1. Create a single abstract element at the top

Figure 76 includes the elements from the XBRL US GAAP Taxonomy that should be used as the topmost element in each presentation relationship group. For the notes, preparers must create an element to be the parent element for all of the notes to the financial statements. A standard label such as “Notes and Disclosures to Consolidated Financial Statements [Abstract]” is suggested (see Figure 52, “An Abstract Element Created in an Extension”).

2. Map each note in the financial statements to one of the text block elements

Just as with the face of the financial statements, preparers should start with the original financial statement notes in a format such as a spreadsheet to record all of the element mappings. To reduce future work on extensions, preparers should create this mapping from an annual financial statement or some other format that includes all the types of notes that the company is certain to have.

There are two main differences in mapping notes as compared to mapping the face of the financial statements. First, preparers should focus their mapping efforts specifically on the text blocks in the XBRL US GAAP Taxonomy that represent entire disclosures. These text block elements are easily recognized: in the presentation relationships, they are either the top element or near the top of each disclosure relationship group and their standard labels end with “[Text Block]”. There are about 110 such text block elements; Figure 84 lists some of the actual text blocks in various relationship groups.

Figure 84 Text Blocks Near the Top of Disclosure Relationship Groups (Presentation Relationships)

820000 – Disclosure – Foreign Operations and Currency Translation	
Foreign Currency Disclosure [Text Block]	<<<
830000 – Disclosure – Leases, Operating	
Leases, Operating [Abstract]	
Operating Leases of Lessee Disclosure [Text Block]	<<<
Operating Leases of Lessor Disclosure [Text Block]	<<<
833000 – Disclosure – Leases, Capital	
Leases, Capital [Abstract]	
Capital Leases of Lessee Disclosure [Text Block]	<<<
Capital Leases of Lessor Disclosure [Text Block]	<<<
836000 – Disclosure – Leases, Sale and Leaseback	
Sale Leaseback Transaction Disclosure [Text Block]	<<<
840000 – Disclosure – Nonmonetary Transactions	
Nonmonetary Transactions Disclosure [Text Block]	<<<
845000 – Disclosure – Related Party Disclosures	
Related Party Transactions Disclosure [Text Block]	<<<

Second, mapping is unlikely to be “one to one” in the way that statement line items are. Even for a simple example like that in Figure 85, a note might contain disclosures that belong in different text blocks, and several financial statement notes might be encompassed by a single text block element (for example, Note 8 and Note 9). The notes encompassed by a single text block may not even be adjacent; Note 4 and Note 7 both fall within the definition of “Loans, Notes, Trade and Other Receivables Disclosure [Text Block]” because the “Other assets” disclosed are notes receivable. Section 6.12 addresses how to add a new Text Block when the appropriate text block does not exist in the US GAAP Taxonomy.

Figure 85 ABC Company and Subsidiaries Notes Mapped to Text Block Elements

	ABC Company and Subsidiaries Note Title	Mapped Element
Note 1	Summary of Significant Accounting Policies	Significant Accounting Policies [Text Block]
Note 2	Related-Party Transactions	Related Party Transactions Disclosure [Text Block]
Note 3	Marketable Debt and Equity Securities	Investments in Debt and Marketable Equity Securities (and Certain Trading Assets) Disclosure [Text Block]
Note 4	Accounts Receivable	Loans, Notes, Trade and Other Receivables Disclosure [Text Block]
Note 5	Inventories	Inventory Disclosure [Text Block]
Note 6	Property, Plant, and Equipment	Property, Plant and Equipment Disclosure [Text Block]
Note 7	Other Assets	Loans, Notes, Trade and Other Receivables Disclosure [Text Block]
Note 8	Short-Term Borrowings	Debt Disclosure [Text Block]
Note 9	Long-Term Debt and Related Matters	Debt Disclosure [Text Block]
Note 10	Stockholders’ Equity	Stockholders’ Equity Note Disclosure [Text Block]
Note 11	Earnings Per Common Share	Earnings Per Share Reconciliation Disclosure [Text Block]
Note 12	Income Taxes	Income Tax Disclosure [Text Block]
Note 13	Rental and Lease Information	Operating Leases of Lessee Disclosure [Text Block]
Note 14	Commitments and Contingent Liabilities	Commitments and Contingencies Disclosure [Text Block]
Note 15	Risks and Uncertainties	Concentration Risk Disclosure [Text Block]
Note 16	Fair Values of Financial Instruments	Fair Value Disclosures [Text Block]

This mapping is a good starting point. In later steps the preparer will exercise judgment to choose from different ways to resolve the inconsistency of having two occurrences of the same element.

3. Copy the mapped elements in the order that the notes appear

Under the topmost abstract element in the extension relationship group for notes and disclosures (such as "Notes and Disclosures to Consolidated Financial Statements [Abstract]"), the preparer should copy the mapped text block elements as presentation children in the same order as they appear in the mapping. Elements must not be repeated, so only the first occurrence should be used. In Figure 85, this would result in fourteen children of the top level abstract element.

4. Mapping text blocks vs. text detail and tables

As explained in [Section 2.1](#), tagging the notes to the financial statements at the text block level is the minimum level of detail. If preparers are content merely to meet the minimum requirement, and all their notes are included within some text block, then the extension is complete.

However, tagging to a finer level of detail increases the usability of the instance document. In most software, tagging with text blocks preserves only the plain text of a disclosure with no formatting other than line breaks. As Figure 86 shows, the plain text is less readable than formatted text.

Figure 86 Plain vs. Formatted Text

<p>(14) Income Taxes</p> <p>The (benefit) provision for income taxes relates primarily to the taxable income of the Company's taxable REIT subsidiaries. The earnings, other than in taxable REIT subsidiaries, of the Company are not generally subject to Federal income taxes at the Company level due to the REIT election made by the Company.</p> <p>Income taxes have been provided for on the asset and liability method as required by Statement of Financial Accounting Standards No. 109, Accounting for Income Taxes. Under the asset and liability method, deferred income taxes are recognized for the temporary differences between the financial reporting basis and the tax basis of assets and liabilities.</p> <p>The Company's (benefit) provision for income taxes for the years ended December 31, 2006, 2005 and 2004 is summarized as follows:</p> <table border="0"> <tr> <td>2006</td> <td>2005</td> <td>2004</td> </tr> <tr> <td colspan="3">Current:</td> </tr> <tr> <td>Federal</td> <td>\$ 139</td> <td>\$ 222</td> <td>\$ 2,249</td> </tr> <tr> <td>State and local</td> <td>331</td> <td>93</td> <td>958</td> </tr> <tr> <td colspan="3">Deferred:</td> </tr> <tr> <td>Federal</td> <td>(581)</td> <td>(358)</td> <td>(1,722)</td> </tr> <tr> <td>State and local</td> <td>(147)</td> <td>(107)</td> <td>(304)</td> </tr> <tr> <td colspan="3">\$ (238) ; \$ (150) ; \$ 1,181</td> </tr> </table> <p>Deferred tax assets of \$3,230 at Balance Sheets at December 31, 2006 and 2005, respectively, are included in other assets on the accompanying Consolidated Balance Sheets at the timing of the recognition of income (loss) carry forwards.</p> <p>The income tax (benefit) provision operating income as follows:</p> <table border="0"> <tr> <td>2006</td> <td>2005</td> <td>2004</td> </tr> <tr> <td>Federal (benefit) provision at statutory rate</td> <td>\$ (548)</td> <td>\$ (96)</td> <td>\$ 1,108</td> </tr> <tr> <td>State and local taxes, net of Federal benefit</td> <td>396</td> <td>(37)</td> <td>(123)</td> </tr> <tr> <td>Other</td> <td>396</td> <td>(30)</td> <td>1,201</td> </tr> <tr> <td colspan="3">\$ (238) ; \$ (150) ; \$ 1,181</td> </tr> </table> <p>As of December 31, 2006, the Company has estimated net operating loss carry forwards for federal income tax reporting purposes of \$11,781, which would begin to expire in tax year 2023. No valuation allowances have been recorded against deferred tax assets as the Company believes they are fully realizable, based upon projected future taxable income.</p>	2006	2005	2004	Current:			Federal	\$ 139	\$ 222	\$ 2,249	State and local	331	93	958	Deferred:			Federal	(581)	(358)	(1,722)	State and local	(147)	(107)	(304)	\$ (238) ; \$ (150) ; \$ 1,181			2006	2005	2004	Federal (benefit) provision at statutory rate	\$ (548)	\$ (96)	\$ 1,108	State and local taxes, net of Federal benefit	396	(37)	(123)	Other	396	(30)	1,201	\$ (238) ; \$ (150) ; \$ 1,181			<p>(14) Income Taxes</p> <p>The (benefit) provision for income taxes relates primarily to the taxable income of the Company's taxable REIT subsidiaries. The earnings, other than in taxable REIT subsidiaries, of the Company are not generally subject to Federal income taxes at the Company level due to the REIT election made by the Company.</p> <p>Income taxes have been provided for on the asset and liability method as required by Statement of Financial Accounting Standards No. 109, Accounting for Income Taxes. Under the asset and liability method, deferred income taxes are recognized for the temporary differences between the financial reporting basis and the tax basis of assets and liabilities.</p> <p>The Company's (benefit) provision for income taxes for the years ended December 31, 2006, 2005 and 2004 is summarized as follows:</p> <table border="1"> <thead> <tr> <th></th> <th>2006</th> <th>2005</th> <th>2004</th> </tr> </thead> <tbody> <tr> <td colspan="4">Current:</td> </tr> <tr> <td>Federal</td> <td>\$ 139</td> <td>\$ 222</td> <td>\$ 2,249</td> </tr> <tr> <td>State and local</td> <td>331</td> <td>93</td> <td>958</td> </tr> <tr> <td colspan="4">Deferred:</td> </tr> <tr> <td>Federal</td> <td>(581)</td> <td>(358)</td> <td>(1,722)</td> </tr> <tr> <td>State and local</td> <td>(147)</td> <td>(107)</td> <td>(304)</td> </tr> <tr> <td colspan="4">\$ (238) ; \$ (150) ; \$ 1,181</td> </tr> </tbody> </table> <p>Deferred tax assets of \$3,230 and \$3,492, respectively are included in other assets on the accompanying Consolidated Balance Sheets at December 31, 2006 and 2005, respectively. These deferred tax assets relate primarily to differences in the timing of the recognition of income (loss) between GAAP and tax, basis of real estate investments and net operating loss carry forwards.</p> <p>The income tax (benefit) provision differs from the amount computed by applying the statutory federal income tax rate to pre-tax operating income as follows:</p> <table border="1"> <thead> <tr> <th></th> <th>2006</th> <th>2005</th> <th>2004</th> </tr> </thead> <tbody> <tr> <td>Federal (benefit) provisions at statutory tax rate (34%)</td> <td>\$ (548)</td> <td>\$ (96)</td> <td>\$ 1,108</td> </tr> <tr> <td>State and local taxes, net of Federal benefit</td> <td>396</td> <td>(37)</td> <td>(123)</td> </tr> <tr> <td>Other</td> <td>396</td> <td>(30)</td> <td>1,201</td> </tr> <tr> <td colspan="4">\$ (238) ; \$ (150) ; \$ 1,181</td> </tr> </tbody> </table> <p>As of December 31, 2006, the Company has estimated net operating loss carry forwards for federal income tax reporting purposes of \$11,781, which would begin to expire in tax year 2023. No valuation allowances have been recorded against deferred tax assets as the Company believes they are fully realizable, based upon projected future taxable income.</p>		2006	2005	2004	Current:				Federal	\$ 139	\$ 222	\$ 2,249	State and local	331	93	958	Deferred:				Federal	(581)	(358)	(1,722)	State and local	(147)	(107)	(304)	\$ (238) ; \$ (150) ; \$ 1,181					2006	2005	2004	Federal (benefit) provisions at statutory tax rate (34%)	\$ (548)	\$ (96)	\$ 1,108	State and local taxes, net of Federal benefit	396	(37)	(123)	Other	396	(30)	1,201	\$ (238) ; \$ (150) ; \$ 1,181			
2006	2005	2004																																																																																																	
Current:																																																																																																			
Federal	\$ 139	\$ 222	\$ 2,249																																																																																																
State and local	331	93	958																																																																																																
Deferred:																																																																																																			
Federal	(581)	(358)	(1,722)																																																																																																
State and local	(147)	(107)	(304)																																																																																																
\$ (238) ; \$ (150) ; \$ 1,181																																																																																																			
2006	2005	2004																																																																																																	
Federal (benefit) provision at statutory rate	\$ (548)	\$ (96)	\$ 1,108																																																																																																
State and local taxes, net of Federal benefit	396	(37)	(123)																																																																																																
Other	396	(30)	1,201																																																																																																
\$ (238) ; \$ (150) ; \$ 1,181																																																																																																			
	2006	2005	2004																																																																																																
Current:																																																																																																			
Federal	\$ 139	\$ 222	\$ 2,249																																																																																																
State and local	331	93	958																																																																																																
Deferred:																																																																																																			
Federal	(581)	(358)	(1,722)																																																																																																
State and local	(147)	(107)	(304)																																																																																																
\$ (238) ; \$ (150) ; \$ 1,181																																																																																																			
	2006	2005	2004																																																																																																
Federal (benefit) provisions at statutory tax rate (34%)	\$ (548)	\$ (96)	\$ 1,108																																																																																																
State and local taxes, net of Federal benefit	396	(37)	(123)																																																																																																
Other	396	(30)	1,201																																																																																																
\$ (238) ; \$ (150) ; \$ 1,181																																																																																																			

No matter what the medium, presenting the information in the notes in an understandable and usable format is essential to effective financial reporting. The best way to communicate the information in the notes, and the interrelationship between that information and the face of the financial statements, is to tag the notes in a detailed manner.

Rule: Map each fact within the notes that also appears in the face of the financial statements.



Rule of Thumb: Map additional facts and disclosures within the notes that are potentially useful to users of the financial statements.



Preparers building the extension to tag individual facts and disclosures within the notes will employ steps 5 and 6 below.

5. For each note, section of text, and table, map to an element

An effective way to tag to a more detailed level than text blocks is to map the notes in several passes. The first pass through the notes produces an initial mapping to text blocks. The next pass would add more presentation children to the text blocks already mapped. A third pass would add detail in tables. Proceeding in this way enables preparers to map large sections of text and grouping topics quickly, while identifying tables that have domains, domain members, and possibly line items in common. This also helps minimize back-tracking later.

The relationship groups in the XBRL US GAAP Taxonomy disclosures have children and other descendants of the topmost text blocks that fall into three categories of importance for mapping:

1. One text block for every table, often with "Schedule" in its name. The text block holds all the detailed, unformatted text appearing in the table. A "Schedule" text block may appear in any disclosure, not just those that model Regulation S-X "Schedules" 12-04, 12-09, and others.
2. Line items having data types such as monetary, per unit, and per share, including some that also appear in the statements. These elements have presentation children almost as they would if the children were in the presentation relationships of a statement.
3. Elements of type "string" for sections of text. The definitions of the string elements have a narrower scope than the disclosure as a whole.

Figure 87 highlights examples of these three categories in the relationship group "320000 – Disclosure – Receivables, Loans, Notes Receivable and Others".

Figure 87 Elements in Receivables, Loans, Notes Receivable, and Others (Presentation Relationships)

Loans, Notes, Trade and Other Receivables Disclosure [Text Block]	
Accounts and Notes Receivable, Gross, Allowance, and Net [Abstract]	
Schedule of Accounts and Notes Receivable [Text Block]	<<1
Schedule of Accounts and Notes Receivable [Table]	
Accounts and Notes Receivable, Type [Axis] ...	
Accounts, Notes and Loans Receivable [Line Items]	
Accounts, Notes and Loans Receivable, Classified [Abstract]	
Accounts, Notes and Loans Receivable, Net, Current [Abstract]	
Accounts Receivable, Net, Current [Abstract]	
Accounts Receivable, Gross, Current	<<2
Allowance for Doubtful Accounts Receivable, Current	<<2
Accounts Receivable, Net, Current, Total	
Notes and Loans Receivable, Net, Current [Abstract] ...	
Notes and Loans Receivable, Net, Current, Total	<<2
Accounts, Notes and Loans Receivable, Net, Current, Total	<<2
Long-term Accounts and Notes Receivable, Net, Noncurrent [Abstract] ...	
Accounts and Notes Receivable, Unclassified [Abstract] ...	
Accounts Receivable Additional Disclosures [Abstract]	
Accounts Receivable, Additional Narrative Disclosure	<<3

6. Add each element to the text block representing the note

For the details of a note, the preparer should add elements as presentation children of the note's text block as a whole. For example, Figure 88 shows an original layout, and Figure 89 shows how a preparer should map the note to elements and presentation relationships.

Figure 88 Accounts Receivable Note, ABC Company and Subsidiaries, Original Layout

Note 4: Accounts Receivable		
At 2013 and 2012, accounts receivable is comprised of the following:		
(In thousands)	2013	2012
Trade receivables	\$ 24,983	\$ 23,936
Less: Allowance for doubtful accounts	900	808
Plus: other receivables	55	83
Total	\$ 24,138	\$ 23,211

Credit is extended to customers only after an evaluation of the customer's financial condition. Generally, collateral is not required.

Figure 89 Accounts Receivable Note, ABC Company and Subsidiaries (Presentation Relationships)

Original Layout	Mapped Element
Note 4: Accounts Receivable	
At 2013 and 2012, accounts receivable is comprised of the following:	Loans, Notes, Trade and Other Receivables Disclosure [Text Block]
	Schedule of Accounts and Notes Receivable [Text Block]
	Accounts, Notes and Loans Receivable, Net, Current [Abstract]
Trade receivables	Accounts Receivable, Gross, Current
Less: Allowance for doubtful accounts	Allowance for Doubtful Accounts Receivable, Current
Plus: other receivables	Notes and Loans Receivable, Net, Current
Total	Accounts, Notes and Loans Receivable, Net, Current, Total
Credit is extended to customers only after an evaluation of the customer's financial condition. Generally, collateral is not required.	Accounts Receivable, Additional Narrative Disclosure

As explained earlier, preparers should first map all the text blocks and string elements before returning to complete the details of a table. The specifics of the table may change from period to period, so the text block of the table serves as a useful placeholder in future reports even if a particular note uses only a small number of line items and no other axes.

Rule of Thumb: Each text block representing a table in a disclosure should appear in the presentation relationships if any part of that table is mapped.



6.6.5 Add Dimensional Relationships into Notes

After the presentation relationships have been added to the extension taxonomy for notes and disclosures of the financial statements, the preparer will continue with dimensional relationships. The rules applying to dimensional relationships in the statements also apply in the disclosure:

Rule: Do not create an explicit "total" domain member for any domain; the domain element itself represents the total.



Rule: Do not use a domain member and a line item to represent the same financial concept.



An effective method of adding the presentation relationships is for preparers to work separately on each text block representing a table, adding dimensional relationships in the following order:

1. Copy the “[Line Items]” abstract element to be the topmost element.
2. Copy the line item elements needed as children of the topmost element.
3. Copy the table element as the first child of the topmost element.
4. For each axis needed, copy the axis element as a child of the table element, and a domain element as a child of the axis both as its domain and as its default member. An axis is only needed if there are line items that must be “disaggregated” or “decomposed” to distinguish between the values that are reported for the entity as a whole versus other decompositions. Typical axes found in the XBRL US GAAP Taxonomy disclosures concern business segments, instrument types, and geographies.
5. Copy the necessary domain member elements as children of the domain element in the order that they are to be displayed in the table. Choosing an appropriate domain member to distinguish different rows or columns is like choosing any other element; the definition of the member matters more than its current position in relationships or the exact standard label.
6. If the software has a feature that previews table layouts from dimensional relationships, use this feature to verify that the dimensional relationships can recreate the layout.

When a table has more than one axis element as a child of the table element, some software programs use this order to determine a default layout in the horizontal direction of the table. Preparers are free to order the axis elements to achieve a desired effect in their own software, but they should remember that other users will be able to rearrange the display as they see fit.

When a restatement appears in a disclosure, the “Scenario [Axis]” is used (as shown in Figure 65, “Fragment Containing Previously Reported, Adjusting, and Restated Data”). Figure 90 shows an example in which the restatement involves a reclassification of “Proceeds from Issuance of Perpetual Trust Securities” from Operating to Financing; no amounts are shown as adjustments, but there are distinct values for four items. The text of the disclosure is shown as a value of the element “Error Corrections and Prior Period Adjustments, Description”.

Figure 90 Example of a Restatement in a Disclosure

	2006 Previously Reported	2006
Error Corrections and Prior Period Adjustments, Description		The effect of the restatement on the 2006 Consolidated Statement of Cash Flows is as follows:
Schedule of Error Corrections and Prior Period Adjustment Restatement [Table]		
Error Corrections and Prior Period Adjustment Restatement [Line Items]		
Net Cash Provided by (Used in) Operating Activities, Continuing Operations [Abstract]		
Increase (Decrease) in Other Operating Capital, Net	40	(449)
Net Cash Provided by (Used in) Operating Activities, Continuing Operations	2,648	2,159
Net Cash Provided by (Used in) Financing Activities [Abstract]		
Proceeds from Issuance of Perpetual Trust Securities		489
Net Cash Provided by (Used in) Financing Activities	2,719	3,208

A number of disclosures have axis elements that are meant to have hierarchical domains (that is, member elements having other member elements as children). Figure 73, “Components of Equity [Domain]”, offers an example of a hierarchical domain.

Figure 74 Validation Messages about Dimensional Relationships shows validation messages that may appear while adding dimensional relationships.

The technical rules used in the XBRL US GAAP Taxonomy prohibit preparers from creating an overall table for *all* of the elements in a relationship group *and* including separate, individual tables *within* the

relationship group. In other words, preparers cannot create a table within (as a descendant of) another table.

Rule: Do not create or move a table inside another table. 

6.6.6 Add Calculation Relationships into Notes

The relationship groups for disclosures in the XBRL US GAAP Taxonomy contain calculation relationships similar to those in the relationship groups for statements. Therefore, in the relationship group in the extension that represents the notes, preparers will copy and add relationships between elements to reflect the reporting structure in much the same way as described for statements. There are three aspects that are different.

First, preparers should not add calculation relationships to the disclosures that are already in a statement. For example, Figure 87 showed a disclosure in which the “Accounts Receivable, Net, Current” element, the gross, and the allowance for doubtful accounts all appear. If the preparer had already copied a calculation relationship between these three elements into the Statement of Financial position, then copying the calculation relationship again into the notes would be redundant, and worse, could introduce calculation inconsistencies that did not appear before.

Rule of Thumb: Calculation relationships among the same elements should not appear in both the statement relationship groups and notes relationship group. 

Second, most calculation relationships that appear in disclosures appear inside tables, between the elements that are presentation children of the “[Line Items]” abstract element. Preparers should focus calculations only on the line items and not attempt to add calculation relationships across any other axes of a table. For example, in Figure 40 (which showed how line items such as cost, gross, and net values related to an axis such as the type of security), calculations in that table are effective with respect to the line items laid out vertically, and have no effect for the securities type axis.

Rule: Create calculations for the line items of a table in calculation relationships. 

Third, a disclosure may show multiple breakdowns of the same figure. In Figure 30 and Figure 31, for example, deposits were broken down two different ways: by type and by source. Often a table is used to report such data, but not always. Figure 91 shows that the “main” presentation group in this example will contain different abstract elements to group each of the alternatives, while the calculations must be in separate relationship groups.

Figure 91 Deposits Example, Repeated

Presentation Relationships		Calculation Relationships	
Group: Main		Group: Main	
Deposits by Type [Abstract]		Deposits	200
Demand Deposits	130	+ Demand Deposits	130
Time Deposits	70	+ Time Deposits	70
Deposits, Total	200		
Group: By Customer Alternative		Group: By Customer Alternative	
Deposits by Customer [Abstract]		Deposits	200
Deposits, Retail	180	+ Deposits, Retail	180
Deposits, Wholesale	20	+ Deposits, Wholesale	20
Deposits, Total	200		

Two rules apply to this situation. One applies to the total element (in this example, “Customer Deposits”) and its children in calculation relationships; the other applies to that same element as it will appear with siblings in presentation relationships:

Rule: If an element is the total of more than one set of calculation children, create separate relationship groups for each set. 

Rule: If the total element of a calculation must appear in a relationship group with different presentation siblings, each set of siblings must have a different abstract element as parent. 

Figure 62 shows validation errors and warnings that might occur while adding calculation relationships.

6.7 Method 7: Suppress or Change a Parent-Child Relationship in the XBRL US GAAP Taxonomy

In general, no relationship in one group interacts with relationships of the same kind in any other group. Therefore, the only reason that a preparer would need to *modify* an existing relationship in the XBRL US GAAP Taxonomy would be to resolve a validation error or calculation inconsistency resulting from one of the few situations where different relationship groups do interact:

1. An axis element must have only one default domain member anywhere in the taxonomy; this would lead to a validation error.
2. Facts in an instance document are checked for consistency using all the calculation relationships in the statement, disclosure, and schedule relationship groups used by the instance document.

To solve these problems the preparer must make sure that the extension taxonomy does not have any offending relationships in it. Depending on the software used, this may appear to the user as “detaching” a child from its parent, “prohibiting” the parent-child relationship, or some other terminology such as “deleting”. This guide’s term for all such approaches is: to [suppress](#) the relationship. The preparer finds the parent element in the relationship, verifies that the relationship in question is specifically in the relationship group where the error occurred, and suppresses the relationship with the specific child of that relationship.

To resolve case 1, preparers must find every dimensional relationship group in the XBRL US GAAP Taxonomy where the axis element occurs, then suppress all child relationships in that dimensional relationship group.

To resolve case 2, preparers must first verify that there is no substantive cause for the inconsistency that should be corrected in the extension taxonomy or in the values reported in the instance document. Further action should be taken only when the element’s sum is clearly a discrepancy between the desired calculation in the company’s own statement or disclosure relationship groups. Then the preparer should find the element whose sum is inconsistent with the reported value, and in every calculation relationship group of the XBRL US GAAP Taxonomy for which that element is the parent, suppress all relationships with children whose values are reported in the instance.

[Appendix C](#), *Extension Naming and Files*, offers advanced techniques for achieving the same effect without suppressing any relationships, as well as producing a more compact set of files.

Figure 45, “Methods of Extending a Taxonomy”, arranged the methods in order of increasing impact on the reusability of the taxonomy and hence the instance documents. Preparers can use methods 1 through 7 to create an extension taxonomy with little negative impact on reusability, because none of them create elements that appear in an instance document. Methods 8 through 12, however, add new elements that will appear in instances. Preparers must take care to create only necessary elements, and to provide accurate definitions and relationships. Methods 8 through 12 explain how to do this for different kinds of elements that have increasing impact on reusability.

6.8 Method 8: Add a New Domain Member Element to an Existing Table Domain

A preparer must add a domain member to an extension when an axis element in the XBRL US GAAP Taxonomy is specifically intended for company-specific information (for example, the Major Customers axis in Figure 43). Figure 92 shows the attributes for a domain member, using the example “US Federal Government” major customer as an example.

Figure 92 Attributes of a Domain Member Element

Attribute	Example	Description
Element name	UsFederalGovernmentMember	The "camel case" version of the standard label, dropping punctuation.
Element ID	abc_UsFederalGovernmentMember	Start with the namespace prefix , underscore ("_") and the element name.
Substitution group	Item	Select "item"
Data type	domain item type	Select "domain item type"
Period type	Duration	Select "duration"
Balance type		Leave blank
Abstract	False	Select "false"
Label, Standard	US Federal Government [Member]	End the label with "[Member]".
Definition		Required. Describe, in full sentences, the scope and intended meaning of the element.
Other Labels		Domain elements do not need any other labels.

Once the domain member has been created, it may be copied into any dimensional parent-child relationship where it would be the child of a domain. Validation errors that may occur as a result of adding domain members are shown in Figure 74.

When an axis of the XBRL US GAAP Taxonomy already has several domain members, the preparer should strive to find an appropriate domain member from those that exist.

Some tables have company-specific domains in which the members have no meaning other than to form a list. For example, in the XBRL US GAAP Taxonomy's relationship group "710000 – Disclosure – Compensation Related Costs", there are tables representing schedules of shares grouped by exercise price range. The element "Share-based Compensation, Shares Authorized under Stock Option Plans, Exercise Price Range, Lower Range [Domain]" is an example of such a domain. Each member of this domain represents a distinct, non-overlapping price range. The upper and lower values of each range are likely to change each period. Therefore, elements such as "Range01", "Range02", and so forth are better to use because each range can have a different upper range and lower range value in each period and each is a per-share line item. The name of the domain, in this case, is of no interest.

Each extension must create member elements wherever the domain is "Segment, Business [Domain]" (see Figure 63), because business segments are specific to the reporting company. New domain members representing each segment must be added as siblings of "Business Intersegment, Eliminations [member]". Furthermore, a number of disclosures have axis elements that are meant to have hierarchical domains (that is, member elements having other member elements as children). The "Entity [Domain]" in Figure 63 is an example of a hierarchical domain. Focusing on "Entity [Domain]" as an example, each affiliated entity, subsidiary (guarantor or non-guarantor) or joint venture that is separately reported in an instance document must be represented with a distinct domain member element. Domain members representing unconsolidated majority-owned entities would have "Majority-Owned Entity, Unconsolidated [Member]" as their parent, partnerships would have "Partnership Interest[Member]" as their parent, and so on.

6.9 Method 9: Add a New Axis to an Existing Table

If the axes of an existing XBRL US GAAP Taxonomy table are insufficient to capture a complex disclosure, a preparer may need to add an axis element. For example, in the XBRL US GAAP Taxonomy relationship group "360000 – Disclosure – Property, Plant and Equipment", there is a table for "Long-lived Assets Held-for-sale by Asset Type" that has an axis for the asset type. If the preparer needs to disaggregate an asset type (property, for example) according to geographic region, then a new axis element will be needed for region. Figure 93 shows how the new axis element, "Long-lived Assets Held-for-sale by Location [Axis]" appears in dimensional relationships.

Figure 93 Long-lived Assets Held-for-sale, with New “Location” Axis (Dimensional Relationships)

Element Label	New Relationship
Long-lived Assets Held-for-sale by Asset Type [Line Items] Schedule of Long-lived Assets Held-for-sale [Table] Long-lived Assets Held-for-sale by Asset Type [Axis] Long-lived Assets Held-for-sale, Name [Domain] Long Lived Assets Held-for-sale by Location [Axis] Segment, Geographical [Domain] Segment, Geographical [Domain] Assets Held-for-sale, Long-lived Long-lived Assets Held-for-sale, Impairment Charge Long-lived Assets Held-for-sale, Proceeds from Sale Long-lived Assets Held-for-sale, Gain (Loss) on Sale	Table-Axis Axis-Domain Axis-Default

As noted in an earlier rule of thumb, axes cannot usually be shared between tables, so adding an axis almost always means creating an axis element. Domain elements, however, can be shared, and this example uses the existing domain element “Segment, Geographical [Domain]”. Figure 94 shows the required attributes of an axis element. The XBRL US GAAP Taxonomy naming convention for an axis has the base name of the table, followed by a comma and the name of the domain, ending with “[Axis]”.

Figure 94 Attributes of an Axis Element

Attribute	Example	Description
Element name	LongLivedAssetsHeldForSaleByLocationAxis	The “ camel case ” version of the standard label, dropping punctuation.
Element ID	abc_LongLivedAssetsHeldForSaleByLocationAxis	Start with the namespace prefix , underscore (“_”) and the element name.
Substitution group	dimensionItem	Select “dimensionItem” (the XBRL technical term for an axis)
Data type	string	Select “string”
Period type	Duration	Select “duration”
Balance type		Leave blank
Abstract	True	Select “true”
Label, Standard	Long-lived Assets Held-for-sale by Location [Axis]	End the label with “[Axis]”.
Definition		Required. Describe, in full sentences, the intended use of the axis, and in particular its intended domain.
Other Labels		Axis elements do not need any other labels.

If an axis must be created, a domain element may or may not need to be created. In this example, the domain does not need to be created. Figure 95 shows the required attributes of the domain element as if it had been created in an extension. The domain element name should be chosen to indicate what the members of the domain will be. For most purposes, different domains may share the same members, but the domain element itself can only be shared by different axes if it *always* has *exactly* the same members.

Figure 95 Attributes of a Domain Element

Attribute	Example	Description
Element name	SegmentGeographicalDomain	The " camel case " version of the standard label, dropping punctuation; this may be automated by taxonomy software if preparers simply provide a standard label.
Element ID	us-gaap_SegmentGeographicalDomain	Start with the namespace prefix , underscore ("_") and the element name; taxonomy software always automates this.
Substitution group	Item	Select "item"
Data type	domain item type	Select "domain item type"
Period type	Duration	Select "duration"
Balance type		Leave blank
Abstract	False	Select "false"
Label, Standard	Segment, Geographical [Domain]	End the label with "[Domain]".
Definition	The name of a geographic segment representing facts about a reporting entity disaggregated by the geographic area of the entity's activities. This element may be used to identify operations in an individual country or group of countries depending on materiality.	Required. Describe, in full sentences, the scope and intended meaning of the element.
Other Labels		Domain elements do not need any other labels.

The preparer may copy the new axis element and domain element into dimensional relationships just as any other axis and domain element, as in Figure 72, "Multiple Stock Classes (Dimensional Relationships)". If the software in use has a feature that previews table layouts from dimensional relationships, the preparer should use it to verify that the dimensional relationships can recreate the desired layout.

The table below interprets error or warning messages about new axis or domain elements that preparers may encounter while editing an extension taxonomy.

Figure 96 Extension Taxonomy Validation Messages about New Axis and Domain Elements

Severity	Message	Solution
Error	Substitution group does not match type	Verify that the type and substitution group attributes of the elements are exactly as they appear in Figure 92, Figure 94 and Figure 95.
Error	Dimension item must be abstract	Verify that the axis element is abstract.

Figure 74 shows validation errors that may occur as a result of creating relationships involving the new axis and domain elements.

6.10 Method 10: Add a New Table

The XBRL US GAAP Taxonomy includes required disclosures and common reporting practices in five industries (CI, BASI, BD, INS, and RE) and contains over two hundred tables. Preparers must perform a top-down analysis of available tables and decide whether an existing table is close enough to simply modify the table in an extension, rather than creating a whole new table. Modifying an existing table, as described in previous sections, is easier and more desirable than creating a new table and its

supporting elements. One reason that a preparer might need to create a new table is to meet a reporting goal, such as reporting key performance indicators by business segment, that is not included in the XBRL US GAAP Taxonomy.

Rule of Thumb: Only create a new table to meet a reporting goal that cannot be met by modifying an existing table from any existing industry entry point.



In the following example, a company has a financial statement note that discloses its deferred revenue by business segment, which is not included in the XBRL US GAAP Taxonomy. Figure 97 illustrates the attributes of an added table, and Figure 98 the attributes of the line items.

Figure 97 Attributes of a Table Element

Attribute	Example	Description
Element name	DeferredRevenueBySegmentTable	The " camel case " version of the standard label, dropping punctuation.
Element ID	abc_DeferredRevenueBySegmentTable	Start with the namespace prefix , underscore ("_") and the element name; taxonomy software always automates this.
Substitution group	Hypercube	Select "hypercubeItem" (the XBRL technical term for a table is "hypercube").
Data type	String	Select "string"
Period type	Duration	Select "duration"
Balance type		Leave blank
Abstract	True	Select "true"
Label, Standard Definition	Deferred Revenue by Segment [Table]	End the label with "[Table]".
	Schedule of deferred revenue disclosure which includes the segments and the corresponding amount that comprise the current and noncurrent balance of deferred revenue as of the balance sheet date.	Required. Describe, in full sentences, the intended use of the Table as distinct from the many other available table elements.
Other Labels		Table elements do not need any other labels.

Rule: Include a "line items" abstract element for each newly created table in an extension.



Figure 98 Attributes of a Line Items Element

Attribute	Example	Description
Element name	DeferredRevenueBySegmentLineItems	The " camel case " version of the standard label, dropping punctuation.
Element ID	abc_DeferredRevenueBySegmentLineItems	Start with the namespace prefix , underscore ("_") and the element name; taxonomy software always automates this.
Substitution group	item	Select "item"
Data type	String	Select "string"
Period type	Duration	Select "duration"
Balance type		Leave blank
Abstract	True	Select "true"
Label, Standard	Deferred Revenue by Segment [Line Items]	End the label with "[Line Items]".
Definition	Consists of current and noncurrent amounts of deferred revenue by segment.	Recommended but not required for abstract elements.
Other Labels		Abstract elements do not need any other labels.

Finally, for reusability and the other reasons discussed above, a newly created table should be accompanied by a text block, as shown in Figure 99.

Rule: Include a text block element for each newly created table in an extension.

**Figure 99 Attributes of a Table Text Block Element**

Attribute	Example	Description
Element name	ScheduleOfDeferredRevenueBySegmentTextBlock	The " camel case " version of the standard label, dropping punctuation.
Element ID	abc_ScheduleOfDeferredRevenueBySegmentTextBlock	Start with the namespace prefix , underscore ("_") and the element name.
Substitution group	Item	Select "item"
Data type	Text Block	Select "text block"
Period type	Duration	Select "duration"
Balance type		Leave blank
Abstract	False	Select "false"
Label, Standard	Schedule of Deferred Revenue by Segment [Text Block]	Start with "Schedule of" and end with "[Text Block]".
Definition	Discloses the business segments and corresponding amounts that comprise the current and noncurrent balance of deferred revenue as of the balance sheet date.	Required. Describe, in full sentences, the scope and intended meaning of the element.
Other Labels		Text block elements do not need any other labels.

The preparer may copy the new table element and other elements into dimensional relationships just as any other table element. If the software used has a feature that previews table layouts from dimensional relationships, the preparer should use it to verify that the dimensional relationships can recreate the desired layout.

The table below interprets error or warning messages about new axis table elements that preparers may encounter while editing an extension taxonomy.

Figure 100 Extension Taxonomy Validation Messages about New Tables

Severity	Message	Solution
Error	Substitution group does not match type	Verify that the type and substitution group attributes of the elements are exactly as they appear in Figure 97.
Error	Hypercube item must be abstract	Verify that the table element is abstract.

Figure 74 shows validation errors that may occur as a result of creating relationships involving the new table and its descendants.

6.11 Method 11: Add a New Numeric Element Such as a Monetary, Per-share, or Other Amount

Preparers should create a new element *only* if they have thoroughly examined the taxonomy and confirmed that a financial concept reported in their financial statements is not in the taxonomy, and all other alternatives, such as creating new calculation relationships, new domain members, axes or tables, have been exhausted. A new numeric element will have a more significant impact on reusability than any of the methods described so far, because any user of the resulting taxonomy and instance documents will need to review the definition of the new element to determine its meaning and how it should be analyzed.

By following naming conventions, assigning balance attributes from the perspective of overall consistency with other elements, and properly constructing calculation and other relationships using the new element, the preparer can maximize the reusability and usefulness of the new element in the company's extension.

Rule: Include a definition and at least one presentation relationship to other elements for every new element that is created for the extension.



Rule of Thumb: Include at least one calculation relationship to other elements for every new numeric element that is created for the extension.



Rule of Thumb: Include a balance attribute for a newly created monetary element with a period type "duration" or "instant" that reflects the type of balance that the element would represent in an income statement or balance sheet.



Rule: Do not add new elements to distinguish beginning and ending balances.



There are two situations that motivate creation of a new numeric element:

1. To combine two or more line items (with distinct definitions) into one element.
2. To add additional elements for financial reporting concepts that are not included in the XBRL US GAAP Taxonomy.

Combining two or more line items into one

In Figure 101, the subtotal of Liabilities and Minority Interest does not exist as a separate element in the XBRL US GAAP Taxonomy, although the separate elements "Liabilities" and "Minority Interest" do. Since the entity reports a combined total for these amounts, a new element should be created, as illustrated in Figure 102.

Figure 101 Liabilities and Minority Interest, a Subtotal Element

LIABILITIES AND SHAREHOLDERS' EQUITY		
Liabilities:		
Mortgages and notes payable	\$2,123,174	\$1,139,971
Contract rights payable	12,231	—
Liabilities — discontinued operations	6,064	32,145
Accounts payable and other liabilities	29,313	13,250
Accrued interest payable	10,818	5,859
Dividends payable	44,948	—
Prepaid rent	10,109	10,054
Deferred revenue (net of amortization of \$1,029 in 2006 and \$554 in 2005)	362,815	6,271
	2,599,672	1,207,550
Minority interests	902,741	61,372
	<u>3,502,413</u>	<u>1,268,922</u>
Commitments and contingencies (notes 8, 9, 10, 11, 13 and 15)		
Shareholders' equity:		
Preferred shares, par value \$0.0001 per share; authorized 10,000,000 shares;		
Series B Cumulative Redeemable Preferred, liquidation preference, \$79,000, 3,160,000 shares issued and outstanding	76,315	76,315
Series C Cumulative Convertible Preferred, liquidation preference \$155,000; 3,100,000 shares issued and outstanding	150,589	150,589
Special Voting Preferred Share, par value \$0.0001 per share; authorized and issued 1 share in 2006	—	—
Common shares, par value \$0.0001 per share, authorized 160,000,000 shares, 69,051,781 and 52,155,855 shares issued and outstanding in 2006 and 2005, respectively	7	5
Additional paid-in-capital	1,188,900	848,564
Deferred compensation, net	—	(11,401)
Accumulated distributions in excess of net income	(294,640)	(172,762)
Accumulated other comprehensive income	1,273	—
Total shareholders' equity	<u>1,122,444</u>	<u>891,310</u>
	<u>\$4,624,857</u>	<u>\$2,160,232</u>

Figure 102 Attributes of Liabilities and Minority Interest, a Monetary Element

Attribute	Example	Description
Element name	LiabilitiesAndMinorityInterest	The " camel case " version of the standard label, dropping punctuation.
Element ID	lxp_LiabilitiesAndMinorityInterest	Start with the namespace prefix , underscore (" _") and the element name.
Substitution group	Item	Select "item"
Data type	Monetary	Select "monetary"
Period type	Instant	Select "instant"
Balance type	Credit	Select "Credit"
Abstract	False	Select "false"
Label, Standard	Liabilities and Minority Interest	Use terms consistent with the conventions of the XBRL US GAAP Taxonomy (Figure 128). Do not include leading, trailing or double spaces. Avoid punctuation such as "&" and ":" if possible, since they cannot appear in the element name.
Definition	This element represents the total amount of liabilities and minority interest at the reporting date.	Definitions are required for newly created, non-abstract elements.
Total label	Liabilities and Minority Interest, Total	This line item appears in Figure 101.
Period Start Label	Liabilities and Minority Interest, Beginning Balance	This label and the next are needed if the element will appear in roll-forwards.
Period End Label	Liabilities and Minority Interest, Ending Balance	
Negated Label	(Less) Liabilities and Minority Interest	If the concept appears netted against another value

To complete the example, Figure 103 shows the presentation and calculation relationships where the new element is a parent or child.

Figure 103 Presentation and Calculation Relationships, Liabilities and Minority Interest

Presentation Relationships	Calculation Relationships
Liabilities and Stockholders' Equity [Abstract]	Liabilities and Stockholders' Equity
...	+ Liabilities and Minority Interest
Liabilities, Total	+ Liabilities
Minority Interest	...
Liabilities and Minority Interest, Total	+ Minority Interest
...	
Liabilities and Stockholders' Equity	

Adding elements for financial reporting detailed line items not included in the XBRL US GAAP Taxonomy

All line items in a statement relationship group, and most of those in disclosure and schedule relationship groups, are already line items within a table. Therefore, if a line item has a number of disaggregated values that are not different in kind, preparers should consider adding an axis to the table with appropriate domain members rather than creating new numeric elements. For example, if revenue, costs, and income on an income statement are disclosed separately as line items for "franchise operations", "mail order operations", and "owned stores", this is better handled as an axis added to the table "Statement [Table]" in the income statement.

The distinguishing feature that motivates addition of numeric elements to add detail line items is that the new elements would be siblings of other line items already mapped to existing XBRL US GAAP Taxonomy elements. An example is found in the cash flows statement (Figure 104) of the financial statement used in the previous example (Figure 102). All of the line items in the figure could be mapped to existing XBRL US GAAP Taxonomy elements other than the two highlighted. This is what suggests that they are new line items, rather than some other type of element such as a domain member.

Figure 104 Cash Flows from Financing Activities with Detail Line Items

Cash flows from financing activities:			
Proceeds of mortgages and notes payable	147,045	516,520	159,760
Change in credit facility borrowing, net	65,194	—	(94,000)
Dividends to common and preferred shareholders	(93,681)	(87,111)	(71,446)
Dividend reinvestment plan proceeds	12,525	13,815	10,608
Principal payments on debt, excluding normal amortization	(82,010)	(50,936)	(6,543)
Principal amortization payments	(28,966)	(25,313)	(19,704)
Debt deposits	291	1,334	(1,384)
Origination fee amortization payments	—	—	(29)
Issuance of common/preferred shares	272	80,671	275,644
Repurchase of common shares	(11,159)	—	—
Contributions from minority partners	810	9,412	—
Cash distributions to minority partners	(8,554)	(7,028)	(8,975)
Increase in deferred financing costs	(1,169)	(6,403)	(1,087)
Purchases of partnership units	(115)	(83)	(121)
Net cash provided by financing activities	483	444,878	242,723

Like any element that represents payments, the element "Principal payments on debt, excluding normal amortization" will have a period type of "duration" and a balance type of "credit". The amount of the payments is a positive value, but it is being *subtracted* from the net cash from financing activities and so it is *presented* as a negative amount on the cash flow. Therefore, it needs a negated label. The attributes of the new element are shown in Figure 105, and the calculation and presentation relationships are shown in Figure 106. The new element must be added to the dimensional relationships as well (as shown in Figure 83).

Figure 105 Attributes of Principal Payments on Debt Excluding Amortization Element

Attribute	Example	Description
Element name	RepaymentsOfSecuredDebtExcludingAmortization	The " camel case " version of the standard label, dropping punctuation.
Element ID	lxp_RepaymentsOfSecuredDebtExcludingAmortization	Start with the namespace prefix , underscore ("_") and the element name.
Substitution group	Item	Select "item"
Data type	Monetary	Select "monetary"
Period type	Duration	Select "instant"
Balance type	Credit	Select "Credit"
Abstract	False	Select "false"
Label, Standard	Repayments of Secured Debt, Excluding Amortization	Start with "Schedule of" and end with "[Text Block]".
Definition	This element represents pre-payments of secured debt (such as mortgages). Such payments are in advance of scheduled payments as required by the debt amortization schedule of such borrowing.	Definitions are required for newly created, non-abstract elements.
Negated Label	(Less) Repayments of Secured Debt, Excluding Amortization	This concept appears in a cash flow statement; the value is positive but it is presented as a negated value because it is being subtracted from net cash.
Reference	Presentation reference	This element is a special case of another element, "Repayments of Secured Debt", and could have the same reference.
Publisher	FASB	Must be from Figure 19
Name	Statement of Financial Accounting Standard (FAS)	Must be from Figure 19
Number	95	
Chapter	18, 20b	

Figure 106 Presentation and Calculation Relationships, Repayments of Secured Debt, Excluding Amortization

Presentation Relationships	Calculation Relationships
Net Cash Provided by (Used in) Financing Activities [Abstract] ... Proceeds from Other Equity (Less) Repayments of Secured Debt, Excluding Amortization (Less) Repayments of Secured Debt ... Net Cash Provided by (Used in) Financing Activities	Net Cash Provided by (Used in) Financing Activities + ... + Proceeds from Other Equity - Repayments of Secured Debt, Excluding Amortization - (Less) Repayments of Secured Debt ...

The table below interprets error or warning messages about new numeric elements that preparers may encounter while editing an extension taxonomy.

Figure 107 Extension Taxonomy Validation Messages about New Numeric Elements

Severity	Message	Solution
Error	Incompatible type and substitution group	Verify that the substitution group is "item".
Warning	Element type cannot have a balance	Only a monetary type element can have a balance attribute. Per unit, per share, pure, and other numeric types must not have a balance attribute.
Warning	No standard label	Verify that there is one and only one standard label.
Warning	Duplicate label types	Verify that there is only one label of each type.
Warning	Multiple languages in linkbase	Verify that the language used on all labels is "English (United States)" or "en-US", not "en" or "en-us".

6.12 Method 12: Add a New String, Text Block, Date, or Other Non-numeric Element

Creating a new non-numeric, non-abstract element should always be a last resort. A non-numeric element in an extension has the same reusability drawbacks of a numeric element, without the benefit of calculation relationships to indicate how it relates to other existing elements.

Preparers are sometimes tempted to create a separate non-numeric, string element that contains every distinct paragraph or heading in a financial statement. At a minimum, these elements violate the rule of thumb that an extension taxonomy should include elements that are not likely to change each period. As discussed earlier, the purpose of an instance document is to convey reliable, unambiguous data, so the effort to duplicate original phrasing, layout, and formatting has rapidly diminishing returns.

The creation of a new text block element is appropriate when a new table is created (Figure 99). A text block could also be created to tag text that covers the subject matter of two distinct, existing text blocks. For example, if a company discusses the sale of shares in consolidated subsidiaries and the sale of shares in equity method investees in the same note to the financial statements, neither the "Equity Method Investments [Text Block]" nor "Stockholders' Equity Note Disclosure [Text Block]" would be appropriate to cover all of the disclosures in that note. Accordingly, a preparer should create a new text block for this disclosure. Figure 108 shows the resulting element.

Figure 108 Issuance of Stock by Equity Method Investees, Element

Attribute	Example	Description
Element name	IssuanceOfStockByEquityMethodInvesteesTextBlock	The "camel case" version of the standard label.
Element ID	coke_IssuanceOfStockByEquityMethodInvesteesTextBlock	Start with the namespace prefix, "_" and the element name
Substitution group	Item	Select "item"
Data type	Text Block	Select "text block"
Period type	Duration	Select "duration"
Balance type		Select blank
Abstract	False	Select "false"
Label, Standard	Issuance of Stock by Equity Method Investees [Text Block]	Match the element name and end with "[Text Block]".
Definition (technically, the "documentation label")	Disclosures related to accounts comprising shareholders' equity and equity investment disclosure, or group of investments for which combined disclosure is appropriate.	Required for non-numeric elements

Because the user of the extension taxonomy is entirely dependent on the element definition to understand the purpose of the element and how it is distinct from other elements, non-numeric elements defined in an extension, in addition to being in a presentation relationship, must also have a definition.

Rule: Include a definition for non-numeric elements (string, text block, or date-related type) newly created in an extension.



7 CREATING INSTANCE DOCUMENTS

An XBRL [instance document](#) is a file designed to be read only by computers. It contains business reporting information representing a collection of company, operating, and financial facts using tags from XBRL taxonomies. Instance documents in use around the world include annual financial statements, earnings releases, bank regulatory reports, and tax forms, all encoded in XBRL using different taxonomies. The instance documents discussed in this guide use [tags](#) from the XBRL US GAAP Taxonomy for annual and quarterly financial statements.

Taxonomies hold the instructions for machine consumption, such as the data types, expected balance type, instructions on how items add up, and other data attributes, such as percentage, decimal accuracy, and so forth. An instance document provides all of the business reporting content (the facts or information to be reported) and contextual data (what humans and machines need to understand and analyze the data) in a structured and consistent format.

The purpose of instance documents is to transmit a set of facts. XBRL allows instance documents to be reused across multiple software applications and permits application software to easily extract the data. There is no constraint on how many or how few facts instance documents may contain. A valid XBRL instance document could contain no facts at all, or one fact, or the contents of an entire financial reporting database, which may include paragraphs of text and numerical data, such as a complex financial statement footnote or MD&A. For most uses of XBRL, instance documents consist of individual financial reports (for example, annual reports, quarterly reports, and earnings releases).

Instance documents do not provide information about how the data should be *displayed* to the user in terms of text style, layout, color, and so forth. Some of that information, such as labels, ordering, and hierarchy, is contained in a taxonomy, but for the most part that task is left to software applications. No matter what software is used, setting up the extension taxonomy and instance document properly is critical for any reporting tools to operate effectively and to present the information. Preparers creating the extension and instance documents should consider how the software-specific reporting tools will present the information to users.

7.1 How Do Taxonomies and Instance Documents Work Together?

Taxonomies define concepts and their relationship to other concepts, and the instance document is a report containing the actual data. Figure 109 repeats the earlier diagram of the tagging process to help show how a taxonomy and the instance documents are related. This section focuses on step 3.

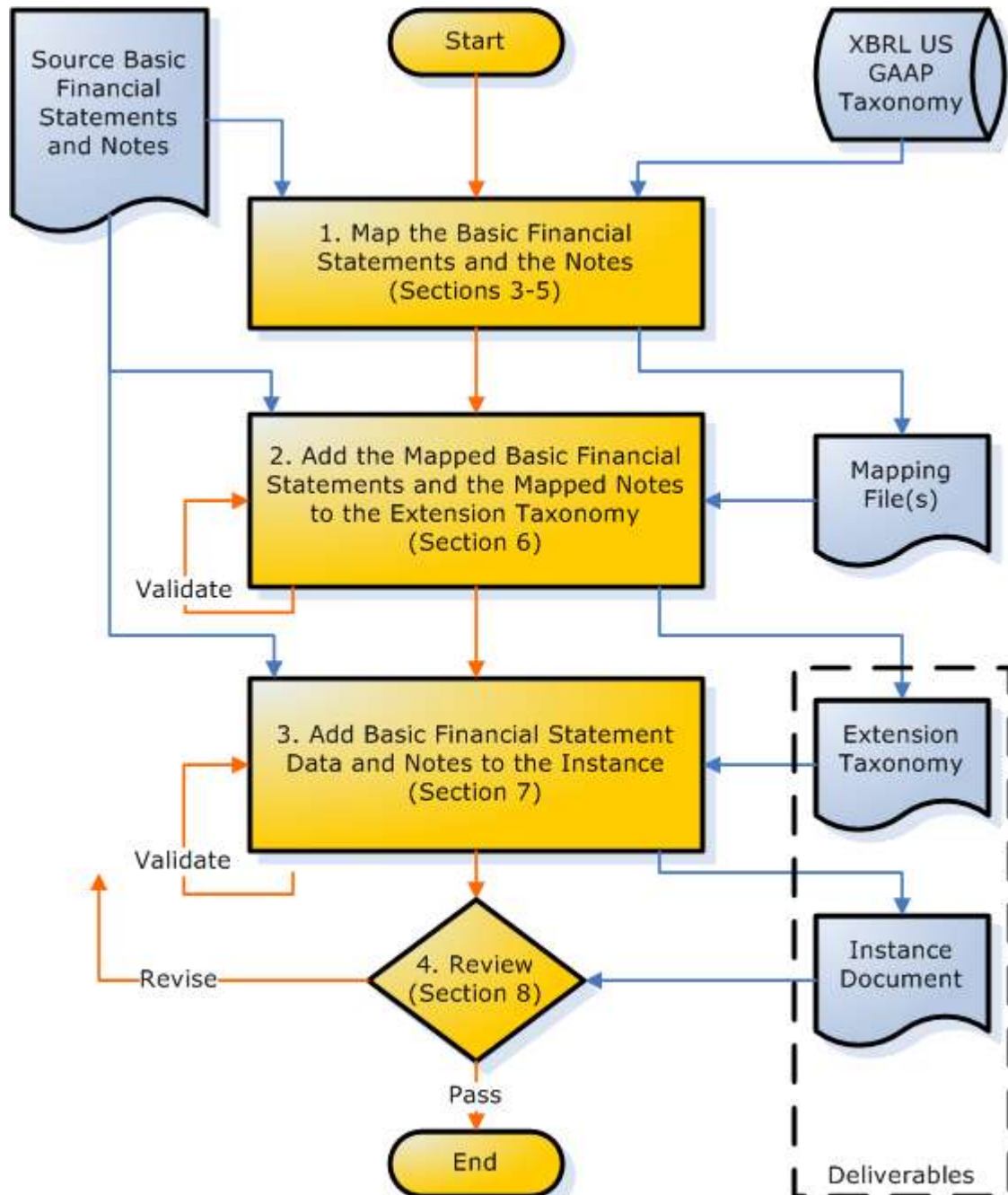
Figure 109 XBRL Instance Document Creation Process

**Orange indicates Process and Process Flow;
Blue indicates Data and Data Flow.**

The instance document can be only as complete and accurate as the XBRL taxonomy. The extension taxonomy determines what can be in an instance document and how it will be interpreted; since it is reusable, it is also longer-lived than the instance document. Preparers must ensure that the taxonomies are appropriately and correctly extended before tagging information in the instance document.

7.2 What Is Included in an Instance Document?

7.2.1 Tags

Tags associate elements with facts in the financial statements. Once preparers have completed the extension taxonomy, the next step is to tag the data. The taxonomy provides the elements and the structure for the financial statements; the instance document is where preparers actually store the company-, period- and report-specific information. An instance document contains many types of data, not just numeric data. It can contain text, ratios, periods, and dates. Figure 110 depicts the parts of a balance sheet defined by a taxonomy (shaded) and the data that will be specific to an instance document (not shaded).

Figure 110 Examples of Information To Be Tagged

ABC Company and Subsidiaries		
Consolidated Balance Sheets		
ASSETS	December 31, 2013	December 31, 2012
Current assets:		
Cash and cash equivalents	\$ 663	\$ 590
Marketable debt and equity securities	6,283	4,632
Accounts receivable (Note 4)	24,138	23,211
Inventories (Note 5)	20,152	21,825
Current deferred tax assets (Note 13)	503	449
Other current assets	908	333
Total current assets	52,647	51,040

[Section 3](#), *Understanding and Using Taxonomies*, details how to create a document that maps each piece of data in the financial statements to the taxonomy.

Rule of Thumb: List each piece of data from the financial statements (numeric or textual) in a spreadsheet or other electronic file. Map the data to the appropriate taxonomy elements, and document the mapping in a separate column of the spreadsheet. 

Figure 111 shows in its rightmost column the XBRL US GAAP Taxonomy element to be used for tagging each value.

Figure 111 ABC Company's Current Assets, with Elements Mapped

XBRL Contexts	December 31, 2013	December 31, 2012	XBRL US GAAP Taxonomy Mapped Element
(In thousands, except share information)			
ASSETS			
Current assets:			Assets, Current [Abstract]
Cash and cash equivalents	\$ 663	\$ 590	Cash and Cash Equivalents, at Carrying Value, Total
Marketable debt and equity securities	6,283	4,632	Marketable Securities, Current, Total
Accounts receivable (Note 4)	24,138	23,211	Accounts Receivable, Net, Current, Total
Inventories (Note 5)	20,152	21,825	Inventory, Net
Current deferred tax assets (Note 13)	503	449	Deferred Tax Assets, Net, Current
Other current assets	908	333	Other Assets, Current
Total current assets	\$ 52,647	\$ 51,040	Assets, Current, Total

The process of tagging requires a software application. The preparer uses software to select the appropriate elements from the taxonomy and creates [contexts](#) that identify the numeric and textual data.

7.2.2 Contexts

In an instance document, the context in combination with an element defines a fact or value in the financial report. A context includes:

- A reporting period, such as a date, a quarter, or a year to date
- An Entity name and identification such as the SEC CIK number
- Axes along which facts are characterized, such as the scenario axis
- The domain member that categorizes facts within each axis, such as “plan” or “forecast”

Contexts apply to both numeric and non-numeric data. A context gives a unique name (ID) to the combination of entity, period, axis, and domain information required to interpret the individual facts in a financial statement.

Rule of Thumb: Include a separate context in the instance document for every combination of the defining information for facts in the financial statement.



Figure 112 gives some descriptions and examples of contexts appropriate for the XBRL US GAAP Taxonomy. This section discusses each in further detail.

Figure 112 Contexts

Context	Description	Example
Context ID	Unique identifier, which must start with a letter and should be descriptive enough to identify a context.	FY07d
Identifier	An identifier for the business entity. A common usage for the identifier is the company CIK code used in SEC filings.	Each consolidated entity (company) requires an Identifier.
Scheme	A URL for referencing the naming authority framework for the identifier.	http://www.sec.gov
Period	Information about the instant or duration of time the fact represents. Instant: a specific date in time (for example, 2002-12-31). Duration: a period of time with both a specific beginning and ending date (for example, income statement period of activity 2002-01-01 through 2002-12-31). Forever: a seldom used duration that is not date limited.	Balance sheet items are measured at a point in time (instant), whereas income statement items measure activity over a span of time (duration).
Period Start	Starting date for reporting period. Required for period type of “duration”.	For January 1, 2007, use 2007-01-01.
Period End	Ending date of reporting period. Required for period type of “duration”.	For December 31, 2007, use 2007-12-31.
Instant	Date for which a value is reported. Required for period type of “instant”.	For June 30, 2008, use 2008-06-30.
Segment	Axes for further characterization of data, when the context refers to something other than the default member of some axis. Although business segments, as defined in FAS 131, are included, contextual segments are much broader. Segments include anything that can be present on a horizontal axis of an XBRL table not otherwise provided for in a context component.	Consolidated, Continuing Operations, Discontinued Operations, Type of Security, Type of Long-Term Debt, and so forth.

7.2.3 Entity Information

The first step in establishing an instance document context is to define the entity's unique company description, which consists of two main parts in XBRL, the identifier and the scheme.

Rule: Use the entire 10-digit Central Index Key (CIK) code assigned by the SEC as the unique company identifier.



Rule: Use a link to the entity's most recent SEC submission from the SEC website as the scheme, either www.sec.gov or the appropriate EDGAR submission link at www.sec.gov/edgar/searchedgar/cik.htm.



7.2.4 Period Information

The period information defines whether the context refers to facts that are measured as of a point in time (instant) or a period of time (duration) and the applicable date or dates. For the period type "duration", there would be both a start and end date. XBRL also includes a period type entitled "forever", but this would rarely if ever be used for a financial statement filing. Also, XBRL recognizes dates only in the CCYY-MM-DD format, which represents a four-digit year followed by a two-digit month and two-digit date.

In the taxonomy, the period type "instant" is used for amounts reported as of a specific date, such as balance sheet amounts. The period type "duration" is used for all other facts.

Rule: Use a duration context for any information, numeric or text, which is not clearly an instant context.



"Duration" requires a period start date and period end date with the format CCYY-MM-DD. In the instance document, XBRL validation ensures that all duration type elements are associated with a duration context, and all instant type elements are associated with an instant context.

7.2.5 Axes and Domain Members

In the XBRL US GAAP Taxonomy, a context has two technical components, the segment and the scenario, that have lost their original meaning. The scenario part of a context is not used; the segment part of a context is where all of the information about the context's axes and domain members is contained. If the context is only about the default value of an axis (for example, it is for the consolidated entity and appears only in a statement) then even the segment component is empty.

7.2.6 Context ID

Even the simplest financial statements will have data characterized by several contexts. Each time a new combination of entity, period, and domain members is selected, a preparer must establish a new context ID. The context ID is a unique identifier that must start with an alphabetic character (per the XBRL specifications) and should be descriptive enough to identify the period and other distinguishing aspects of the context.

Rule of Thumb: Include at least the period and the period type in a context ID.



Rule of Thumb: Do not include the company name in the context ID if there is only one company reported in the instance document.



For example, for ABC Company's fiscal year ended 2007, the context ID might be "FY07d" for durations and "FY07e" for the instant at the end of the period. Figure 113 extends this convention to quarters and "Year to Date" periods.

Figure 113 Example Context Naming Convention

Period	Context ID
12 months of fiscal 2007	FY07d
End of fiscal 2007	FY07e
Start of fiscal 2007	FY06e
3 months of the 2nd Quarter of fiscal 2007	FY07Q2d
9 months year to date in fiscal 2007	FY07Q3YTDd
End of the 2nd Quarter of fiscal 2007	FY07Q2e
Fiscal 2006 previously reported amounts	FY06d_ScenarioAxis_PreviouslyReportedMember

The final row of Figure 113 shows an example in which the context is for Fiscal 2006 and one domain member ("Scenario, Previously Reported [Member]") in a table axis ("Scenario [Axis]"). Including the axis name and domain member name is explicit, but is tedious and error prone if the ID has to be created by the preparer by hand. Software for instance creation usually has a feature for creating a large number of related contexts and their IDs with a single preparer operation.

7.3 Units and Measures

Every numeric value in an instance document must have a unit, which may be either a simple unit of measure expressed with a single measure element or a ratio of products of units of measure. Simple units include USD (US dollar), EUR (Euros), shares, meters, kilograms, or FTE (full-time equivalents). An example of a ratio is earnings per share (numerator USD, denominator shares). XBRL restricts the type of unit allowed for certain item types:

- Monetary elements must have monetary unit types recognized by the International Standards Organization standard ISO 4217 (see www.iso.org).
- Shares elements must have a unit of "shares".
- Rates, percentages, and ratios represented using a pure or percentage data type must have a unit of "pure". Percentages are represented as decimals. For example, use ".75" rather than "75%".

Figure 114 shows one suggested convention for naming units to refer to the technical symbols used in XBRL. Some software products automate the definition of units.

Figure 114 Example Units Naming Convention

Unit ID	Measure	Numerator	Denominator
usd	iso4217:USD		
shares	xbri:shares		
ratio	xbri:pure		
usdPerShr		iso4217:USD	xbri:shares

Preparers may also define their own units. Figure 115 shows an example in which a company having the [namespace prefix](#) "fvst" reports amounts that refer to a number of stores.

Figure 115 Defining a "Stores" Unit

"Five Star is one of China's largest appliance and consumer electronics retailers, with 135 stores located in seven of China's 34 provinces."

Unit ID	Measure
sto	fvst:stores

7.4 Decimals (and Precision)

"Decimal" specifies the extent to which a number has been rounded. Values that are rounded in financial statements appear in the instance document with trailing zeros. For example, in a financial statement with values rounded to millions, a number reported as \$50 is actually \$50,000,000 and will appear in the instance document as 50000000. Some software adds the additional zeros automatically; other software requires users to add the zeros manually. Of course, a number reported as \$50 rounded to millions is not necessarily equivalent to \$50,000,000. It could represent any number between \$49,500,000 and \$50,499,999. Therefore, anyone comparing data among companies should note that the unrounded numbers presented in instance documents are not, in fact, accurate to the nearest dollar.

“Decimal” is used to express the degree to which numbers have been rounded. The “decimal” value for numbers rounded to thousands is -3 (three digits to the left of the decimal point); the value for numbers rounded to millions is -6 (six digits to the left of the decimal point). On the other side of the decimal point, numeric values rounded to two decimal places (for example, 23.57) would have a “decimal” value of +2. A decimals value of “INF” means that the number is exact; a dividend of \$1.23 per share is exactly 1.23, and therefore has decimals of INF.

Some software offers the option of using “precision” to specify rounding and accuracy instead of “decimals”. “Precision” is an older, less intuitive, and more difficult to use method of specifying rounding and accuracy, which is based on scientific notation.

Rule: Use “decimal”, not “precision” in an instance document and carefully note the terminology used by different software.



7.5 Tagging Values

Rule of Thumb: Define contexts prior to tagging any data to the taxonomy even if the software permits tagging before defining contexts.



After preparers have set up the contexts, they tag the data in their financial statement based on the [mapping](#). Each fact has a context. This process can become confusing due to the large number of contexts involved in the tagging of a full set of financial statements. Therefore, clear and consistent naming of the context ID is essential to ensuring easy context identification.

There are restrictions on how numbers may appear in an instance document. XBRL prohibits commas, percent signs, dollar signs, and any other non-numeric characters (except minus signs to indicate negatives) when tagging values of numeric data in an instance document. Also, confirm that the creation software filters out the entry of invalid characters related to the corresponding data type. Negative values must use a minus sign (-) as a prefix to the value (for example, -100).

Rule: Do not tag any data that does not already appear on the printed financial statements, even if this results in a calculation inconsistency in the calculation relationships file.



7.5.1 Capturing the Full Value/Scaling

Most financial statements round off the trailing zeros and list each statement as “in millions” or “in thousands”. Consistent scaling within the instance document is important, and preparers should be aware of the software’s abilities to scale the amounts in the instance document. Software may or may not save time entering zeros by automatically scaling during the entry or creation process. Regardless of software functionality, preparers must ensure that the XBRL instance document contains the correct number of zeros for each value, even if those zeros do not appear in the printed financial statements.

7.5.2 Sign Values and the Balance Type

When tagging numeric data in the instance document, sign values are used to denote whether the value is positive [+] or negative [-]. It is critical to ensure consistency in the use of sign values to aid reusability and consistency of instance documents.

Rule: Enter a positive number in the instance document if the value has the same balance (debit or credit) as the element’s balance type.



For example, if entering an amount for “Cash and Cash Equivalents, at Carrying Value” on the balance sheet, enter this as a positive value as long as the amount being entered is a debit balance, which is the balance type specified for that element in the XBRL US GAAP Taxonomy. If an element has a credit balance type, and the balance is also a credit, enter it as a positive value.

	Debit	Credit
Debit	+ 1	-1
Credit	-1	+1

Not all monetary elements have a balance type. The XBRL US GAAP Taxonomy Statement of Cash Flows includes some elements with no balance type which represent changes in current asset and liability balances and are used to adjust net income to cash flow from operations such as Increase (Decrease) in Operating Liabilities.

Rule of Thumb: Assign values consistent with the sign values used to enter numbers into the instance document. The proper sign value may be indicated in the element standard label. 

For instance, in the XBRL US GAAP Taxonomy, the element that represents the net change in all operating assets and liabilities has the label "Increase (Decrease) in Operating Capital, Total". Therefore, increases in operating capital should be entered as positive numbers while decreases in operating capital would be entered as negative numbers. Similarly, a label that includes "(Gain) Loss" indicates that gains are to be entered as negative numbers, by use of the parentheses, while losses are to be entered as positive numbers since the "Loss" is not in parentheses.

There are a few elements in a calculation relationship that subtracts one element from another yet both elements have the same balance type. The XBRL US GAAP Taxonomy contains monetary elements with *no* balance type specifically for these common situations; such elements include, but are not limited to:

- Adjustments to Reconcile to Income (Loss) from Continuing Operations
- Net Cash Provided by (Used in) Operating Activities
- Net Cash Provided by (Used in) Operating Activities, Continuing Operations
- Net Cash Provided by (Used in) Financing Activities
- Net Cash Provided by (Used in) Financing Activities, Continuing Operations
- Net Cash Provided by (Used in) Investing Activities
- Net Cash Provided by (Used in) Investing Activities, Continuing Operations
- A Period Increase (Decrease) element, which is a net value within a roll-forward

7.5.3 Tables

[Tables](#) let preparers tag data for line items that are disaggregated along one or more axes. As described in [Section 6, Creating Extensions](#), instance documents containing multiple reports, entities, or classes of stock will have primary financial statements that are tables. However, most preparers will only use tables for detailed tagging of the notes. Figure 116 provides an example from a debt and equity securities note.

Figure 116 Disclosure Example Using a Table

Note 3: Marketable Debt and Equity Securities

Investments in marketable debt and equity securities at December 31, 2013 and 2012 are as follows:

	Cost	Gross Unrealized Gain	Gross Unrealized Losses	Estimated Fair Value
December 31, 2013:				
Available for sale:				
US Treasury notes	\$4,163	\$—	\$—	\$4,163
Corporate debt securities	961	253	58	1,156
Equity securities	302	729	67	964
Total	\$5,426	\$982	\$125	\$6,283
December 31, 2012:				
Available for sale:				
US Treasury notes	\$2,767	\$—	\$—	\$2,767
Corporate debt securities	1,219	64	57	1,226
Equity securities	831	117	309	639
Total	\$4,817	\$181	\$366	\$4,632

Figure 117 repeats a figure from [Section 5, Using Tables](#), which illustrates that the table as shown in dimensional relationships with line items on the vertical axis and domain members on the horizontal axis may be quite different from the original table appearing in a financial statement.

The way that software displays a table when creating an instance document depends on the software and the preferences of the preparer. Software can always change the transposition of the horizontal and vertical axes. Figure 118 illustrates one of the many ways a table can appear.

When a table has more than one axis element, a preparer may reorder the horizontal axes of the table in the dimensional relationships of the extension to achieve a desired effect. However, preparers should not use the extension taxonomy to transpose the horizontal and vertical axes. Instead, preparers should use the display features of their software to adjust the display of the table.

Rule of Thumb: Do not extend the taxonomy to transpose the axes of a table.



Figure 117 Line Items, Domains, and Domain Members in a Table

		Domain			
		U S Treasury Notes	Corporate Debt Securities	Equity Securities	Total
Vertical	December 31, 2013	Available for Sale			
	Cost				
	Gross Unrealized Gains				
	Gross Unrealized Losses				
	Estimated Fair Value				

Horizontal

Line Items

Domain Members

Table

Preparers tag data with the contexts that use the axes and domain members of a table. The software will determine the way preparers enter this information. Some software sets up the information in a format similar to that in Figure 118, and preparers simply need to enter values, units, and decimals. Preparers should understand the features of their software that will ease this process.

Figure 118 Facts in a Table

	Line Items	Domain Members			
		US Treasury Securities	Corporate Debt Securities	Equity Securities	(Implicit Total)
2013-12-31	Schedule of Available-for-Sale Securities, Amortized Cost		↙	↗	
2013-12-31	Schedule of Available-for-Sale Securities, Gross Unrealized Gains	←	<i>Data Input Area 2013</i>		→
2013-12-31	Schedule of Available-for-Sale Securities, Gross Unrealized Losses		↙	↘	
2013-12-31	Schedule of Available-for-Sale Securities, Noncurrent				
2012-12-31	Schedule of Available-for-Sale Securities, Amortized Cost		↙	↗	
2012-12-31	Schedule of Available-for-Sale Securities, Gross Unrealized Gains	←	<i>Data Input Area 2012</i>		→
2012-12-31	Schedule of Available-for-Sale Securities, Gross Unrealized Losses		↙	↘	
2012-12-31	Schedule of Available-for-Sale Securities, Noncurrent				

Figure 119 illustrates the technical details of how the context of each fact in a table is defined. Each context has a period, so in the figure there must be at least two contexts, one set for the balance at the end of 2013 (FY13e) and one for the balance at the end of 2012 (FY12e). The "Type of Security" and its domain of three members mean that there must be at least three contexts for each of the two periods. Finally, when the security type is not specified, the default is used, meaning that the contexts FY12e and FY13e are used in that column of the table. This yields a total of eight contexts, which are listed in Figure 119.

Figure 119 Contexts in a Table

	Line Items	Domain Members			
		US Treasury Securities	Corporate Debt Securities	Equity Securities	(Implicit Total)
2013-12-31	Schedule of Available-for-Sale Securities, Amortized Cost	FY13e, "Security Axis = US Treasury Securities"	FY13e, "Security Axis = Corporate Debt Securities"	FY13e, "Security Axis = Equity Securities"	FY13e
2013-12-31	Schedule of Available-for-Sale Securities, Gross Unrealized Gains				
2013-12-31	Schedule of Available-for-Sale Securities, Gross Unrealized Losses				
2013-12-31	Schedule of Available-for-Sale Securities, Noncurrent				
2012-12-31	Schedule of Available-for-Sale Securities, Amortized Cost	FY12e, "Security Axis = US Treasury Securities"	FY12e, "Security Axis = Corporate Debt Securities"	FY12e, "Security Axis = Equity Securities"	FY12e
2012-12-31	Schedule of Available-for-Sale Securities, Gross Unrealized Gains				
2012-12-31	Schedule of Available-for-Sale Securities, Gross Unrealized Losses				
2012-12-31	Schedule of Available-for-Sale Securities, Noncurrent				

Software for instance creation usually has a feature for creating a large number of contexts within a table along with their IDs with a single preparer operation. Other software may hide detail entirely from the preparer.

7.6 Understanding Cash Flow and Calculations

Preparers may encounter calculation issues when entering the values to reconcile net income to net cash provided (used) by operating activities under the indirect cash flow method. These issues arise because the adjustments require that certain elements be removed from or added back to net income, such as the loss on sale of marketable securities or depreciation. Adding back depreciation to net income requires the addition of a debit element (such as depreciation) to a credit element (net income), which is not permitted by the XBRL calculation weight rules.

Another calculation issue arises when calculating the cash flow impact from changes in operating assets and liabilities on the balance sheet. In drafting an indirect cash flow statement outside of XBRL, preparers compute the balance sheet changes occurring between reporting periods and then determine the impact that those changes have on cash flow. For example, in Figure 120 the accounts receivable increase of 927 is an increase in current assets.

The second step in calculating cash flow impact is to determine how an increase in accounts receivable impacts cash flow. An increase in accounts receivable represents a use of cash in the indirect cash flow method. The calculation weight of the relationship between "Net Cash Provided (Used in) Operating Activities" and "Increase (Decrease) in Accounts Receivable" is therefore -1 .

Figure 120 shows the calculation for a portion of a statement of cash flow. The element names and their balances are part of the XBRL US GAAP Taxonomy and cannot be changed. For illustration, the fact values are shown multiplied by their calculation weight to arrive at a "contribution" to the total net cash from operating activities.

**Figure 120 ABC Company – Net Cash Provided (Used) by Operating Activities
(Calculation Relationships)**

Element	Element Balance Attribute	Fact Value in 000's	Calculation Weight	Contribution = Weight x Fact Value
NetCashProvidedByUsedInOperatingActivities		5,353		5,353
NetIncomeLoss	Credit	1,369	+1	1,369
DeferredIncomeTaxExpenseBenefit	Debit	350	+1	350
DepreciationAndAmortization	Debit	1,387	+1	1,387
GainLossOnSaleOfEquityInvestments	Credit	(336)	-1	336
GainLossOnSaleOfPropertyPlantEquipment	Credit	266	-1	(266)
IncreaseDecreaseInAccountsReceivable	Credit	927	-1	(927)
IncreaseDecreaseInInventories	Credit	(1,673)	-1	1,673
IncreaseDecreaseInOtherOperatingAssets	Credit	581	-1	(581)
IncreaseDecreaseInAccountsPayableTrade	Debit	855	+1	855
IncreaseDecreaseInEmployeeRelatedLiabilities	Debit	948	+1	948
IncreaseDecreaseInOtherOperatingLiabilities	Debit	209	+1	209

Figure 120 shows calculation relationships, not presentation relationships. For any presentation relationships on which the preferred label is a [negating label](#), the value would be displayed with a sign flip, as explained in [Section 6.3](#) above. Figure 121 illustrates how this could be done for the cash flow in Figure 120. A preparer would in this way achieve the effect of displaying the values in the “contribution” column rather than the fact value.

**Figure 121 ABC Company – Net Cash Provided (Used) by Operating Activities
(Presentation Relationships)**

Element Label	Fact Value in 000's	Weight	Preferred Label Type	
Net Cash Provided By (Used In) Operating Activities [Abstract]				
Net Income (Loss)	1,369	+1		1,369
Deferred Income Tax Expense (Benefit)	350	+1		350
Depreciation and Amortization	1,387	+1		1,387
(Gain) Loss On Sale of Equity Investments	(336)	-1	Negated	336
(Gain) Loss On Sale Of Property Plant and Equipment	266	-1	Negated	(266)
(Increase) Decrease In Accounts Receivable	927	-1	Negated	(927)
(Increase) Decrease In Inventories	(1,673)	-1	Negated	1,673
(Increase) Decrease In Other Operating Assets	581	-1	Negated	(581)
Increase (Decrease) In Accounts Payable, Trade	855	+1		855
Increase (Decrease) In Employee Related Liabilities	948	+1		948
Increase (Decrease) In Other Operating Liabilities	209	+1		209
Net Cash Provided By (Used In) Operating Activities	5,353			5,353

However, the presentation relationships and preferred labels have no effect on calculation relationships and therefore do not impact consistency. When the calculation relationships lead to a difference between a calculated total and the value tagged as the total, XBRL-enabled software notifies the user of a calculation inconsistency. Calculation inconsistencies are not considered errors, because they may represent missing, but easily inferred, information, or rounding errors rather than errors in the tagging of the financial statements. Calculations may be inconsistent for a number of reasons.

Rule of Thumb: Examine the cause of each calculation inconsistency that is identified in the instance document to determine whether it is an error or an “expected” inconsistency.



As previously discussed, when data is tagged for an element while creating an instance, the value will appear everywhere that element appears in the taxonomy. Although this is an important benefit, it

can cause anomalies. For example, a few of the same elements appear in the calculation relationships of both the income and cash flow statements. This may result in one of the statements being partially populated. If any element is a total element in a calculation without some of its contributing values, it may result in a calculation inconsistency. In this particular case, an extension can suppress the calculation relationships that result in the inconsistency. This same anomaly may occur in other situations, such as in disclosures that share elements with the statements. Finally, as in any financial report, rounding of numbers for presentation may lead to apparent inconsistencies. In such cases, preparers may decide to simply accept the existence of the calculation inconsistency. Users of the instance document will be alerted by their XBRL-enabled software that the inconsistency exists. There are various ways for preparers to mitigate any negative perceptions this creates (see [Section 6, Creating Extensions](#)).

7.6.1 Zero and Nil

A zero value denotes that the value of a fact is zero. A “nil” value denotes that a value does not exist for that fact, perhaps because the value is not determinable. It is always preferable to simply leave a fact value out when it is zero or nil; there should be some reason for the fact to appear in the instance document. For example, “Commitments and Contingencies” appears in the balance sheet. No value is associated with this line item, but it is not a zero balance because the value is not determinable. Preparers should use the “nil” attribute when they want the Commitments and Contingencies element to be displayed in the balance sheet and its values are not determinable.

7.7 XBRL Footnotes

Preparers often associate the term “footnote” with the Notes to Consolidated Financial Statements. An XBRL “footnote” refers only to the superscripts and text that appear at the bottom of a page. XBRL footnotes are specific to an instance document rather than built into taxonomies. They can be tied only to a particular report from a particular entity at a specific period of time.

To add an XBRL footnote, the preparer must link it to at least one fact in the instance document. Footnotes use “locators” (analogous to “named ranges” used in spreadsheet software) that name instance document facts. Both the fact and the footnote reside in the same XBRL instance document. One footnote can be linked to multiple facts. A preparer could create a single footnote and link it to facts throughout multiple financial statements. Likewise, a single fact can be linked to multiple footnotes. A footnote may be linked to zero or nil-valued facts.

Instance document creation tools provide for the process of entering the footnote and linking it to the financial fact(s) in an intuitive way. Figure 122 provides an example of footnote text (footnote †, shown bold) that might be linked to financial data as part of an income tax footnote.

Figure 122 Footnote Example

(in thousands)	2013	2012
Deferred tax liabilities:		
Depreciation	\$ 614	\$ 301
Other—net	(31)	34
Total deferred tax liabilities	583	335
Deferred tax assets:		
Net operating loss carryforwards	1,709	2,248
Tax credit carryforwards	486	443
Other—net		157
Total deferred tax assets	2,195	2,848
Valuation allowance for deferred tax assets	100†	1,350
Deferred tax assets	2,095	1,498
Net deferred tax assets	\$1,512	\$1,163

† For financial purposes, a valuation allowance of \$100,000 has been recognized to offset the deferred tax assets related to the state income carryforwards.

7.8 Validating the Instance Document

Instance document validation involves running XBRL validation software on an instance document to check compliance of the instance document with the technical rules of the XBRL specification. Software may build some of the validation requirements into the creation process, prompting preparers when they enter incorrect, or fail to enter, information. Examples of errors that software can prevent include:

- Inserting text where the taxonomy calls for a dollar value
- Tagging income statement facts “as of December 31” (instant) instead of tagging them for a period of time (duration)

7.8.1 Calculation Consistency

Calculation consistency checking is defined by the XBRL specification (see [Section 4, Using Taxonomy Calculations](#)). Calculation consistency means that for any element that has a value, and has calculation children with values in the same context, the sum of each of the children multiplied by its calculation relationship weight equals the value of the parent. Depending on the nature and type of error, preparers might need to fix the error in the extension taxonomy elements, in the extension relationships, or in the instance document itself. The following is important information for preparers to correctly interpret the results of calculation consistency checking.

Calculations will work only if all of the values in the calculation are contained within the same context. That is, all values must apply to the same entity and period, as well the same domain members of any axes. This supports many types of calculations, including most income statements and balance sheets, but does not model any kind of roll-forward calculations, including some calculations in the statement of cash flow and statement of shareholders’ equity.

Rounding can result in inconsistencies, as shown in Figure 123. The decimals attribute is set to “2” for all three numbers because that is how many digits are reported in the financial statement.

Figure 123 Rounding

Calculation Relationships		FY13
	Earnings per share, Basic	1.30
+1	Income (Loss) from Discontinued Operations, Net of Tax, Per Basic Share	.01
+1	Income (Loss) from Continuing Operations, Per Basic Share	1.28

In this example, XBRL validation software will identify an inconsistency in FY13. Adjusting the decimals attribute of “2” on the facts to “1” or “3” will not resolve this inconsistency. Adding hidden digits, such as changing .01 to .014 and 1.28 to 1.284, and setting the decimals attribute to “3” may resolve the calculation inconsistency, but the extra digits were not reported in the financial statement. It is a rounding inconsistency and should be left as it is.

Rule: Do not resolve calculation inconsistencies by inserting digits that are not reported in the printed financial statements.



Often, a calculation inconsistency in the original financial statements has a footnote to indicate that the error is due to rounding. If there is such a footnote in the original financial statements then the preparer should create an XBRL footnote to convey the same information as the original.

If an instance document contains a fact for a parent element and at least one fact for the child of a calculation relationship, then XBRL validation always checks the parent fact for calculation consistency. This may result in a calculation inconsistency due to missing facts. For example, assume a simple calculation relationship: Operating Income equals Revenue minus Costs and Expenses. Figure 124 shows five-year financial highlights with Operating Income and Revenues, but not Costs and Expenses for two of the years.

Figure 124 Two Calculation Inconsistencies from Five Years of ABC Company Data

Calculation Relationships	FY13	FY12	FY11	FY10	FY09
Operating Income (Loss)	1,040	960	880	800	720
+1 Revenues	1,300	1,200	1,100	1,000	900
-1 Costs and Expenses	260	240	220		

XBRL validation software will identify two calculation inconsistencies: in FY10, the value 800 does not equal 1,000; in FY09, the value 720 does not equal 900. Do not add extra values to resolve these calculation inconsistencies.

Rule: Do not resolve a calculation inconsistency by inserting a value that is not reported in the printed financial statements.



Calculation relationships in the extension taxonomy that the preparer creates according to the procedure described in [Section 6, Creating Extensions](#) will usually verify the consistency of the data in the statements and disclosures for all periods.

Preparers should find the relationships and facts that are inconsistent and verify that the calculation relationships have the right parent and child elements and that the weights are correct. If the elements and calculations are correct, preparers should then verify that the instance document has the values tagged with the right element, the right signs, and no transposed digits, missing zeroes, or other common data entry error.

Figure 124 shows that sometimes resolving the inconsistency would involve adjustments to the instance or the taxonomy that the rules of thumb and rules in this guide discourage or forbid. For example, creating a new and different element for "Revenues" in periods FY10 and FY09 would resolve the inconsistency but also violate a fundamental rule not to create elements when an element with an appropriate definition already exists. After all other sources of inconsistency have been ruled out, some inconsistencies cannot be resolved, and preparers should leave them in the instance document.

Some vendor products feature "enhanced" validations that compute intermediate subtotals. However, this is a vendor-specific function that is, in effect, hiding from the user calculation inconsistencies. Other users who open the same instance document with other products will see the inconsistencies, possibly concluding that the instance was not prepared with due care.

7.8.2 Validation Software

For the most part, validation programs will be built into the software applications for instance document creation, and will follow XBRL-specific rules. However, not all software will automatically run instance document validations as preparers are tagging data. So each time preparers save the data, they may want to run a validation to be sure the data have been entered properly. This process saves time on the back end of the instance creation process and will help preparers identify and correct errors.

Rule: Run manual validations frequently while information is being tagged in an instance document.



8 REVIEW OF INSTANCE DOCUMENTS

8.1 Management's Responsibilities and Review Objectives

Financial statements in XBRL are management's responsibility.

Management is responsible for the completeness, accuracy, and presentation of the company's financial statements whether those financial statements are "paper-based" or in XBRL (instance documents). XBRL instance documents are only as reliable as the financial information used and the accuracy of the mapping used to create them. Accordingly, a company must develop processes and controls over the creation of instance documents and review procedures to ensure that the documents fairly reflect their financial statements. The following is a sample, but not an exhaustive list, of some of management's responsibilities associated with an instance document:

1. **Appropriate Taxonomy:** The instance document uses the latest published taxonomy that is available on the XBRL US, Inc. website. If files from an industry entry point are referenced, the industry should be appropriate for the entity.
2. **Complete and Accurate Entity Information:** The instance document includes complete and accurate information about the reporting entity.
3. **Completeness of Tagging:** The instance document includes tagged data for all information in the financial statements at least at the required minimum level of detail of tagging described in Section 2, *Getting Started*.
4. **Accuracy of Tagging:** The elements in the instance document accurately represent the concepts in the financial statements that have been tagged.
5. **Company-Specific Elements Justified:** Company-specific elements have been created and used in the instance document only to represent a company-specific [domain member](#), or when an element representing the underlying financial reporting concept did not exist in the latest published taxonomies.
6. **Completeness and Accuracy of the Tags:** The tags used in the instance documents are complete and accurate (whether from the published or extended taxonomies), including their attributes, relationships, and contexts.
7. **Completeness and Accuracy of Labels and Definitions:** Labels of the elements, whether for new elements or whether overriding the label of an XBRL US GAAP Taxonomy element, are reasonable descriptions of the tagged financial reporting concepts.
8. **Completeness and Accuracy of Relationships:** Relationships in the extension taxonomy (presentation, calculations, and dimensions) fully and accurately reflect the relationships of the financial reporting concepts in the financial statements.
9. **Accuracy of Values:** The instance document includes numeric values that are the same as the numerical values in the financial statements.

Additionally, management is responsible for compliance with any regulatory reporting requirements associated with XBRL instance documents.

Management responsibilities for the instance documents are the same whether the company prepares the instance documents internally or uses the services of a third party.

The remainder of this section focuses on the following management responsibilities and associated review objectives.

- Accuracy and completeness of mapping concepts from the financial statements to elements
- Accuracy and completeness of tagging and data entry
- Accuracy of context assignments
- Accuracy and appropriateness of the extension's elements and relationships

8.1.1 Accuracy and Completeness of Mapping

One of the first steps in creating an instance document is developing a map between the published financial statements and elements in the XBRL US GAAP Taxonomy. This map defines the financial data in XBRL terms. This mapping must be accurate and complete, and approved by the appropriate level of authority in the preparer's organization. Preparers should obtain approval from within the organization for the company's mapping before creating the instance document. Otherwise, they might need to duplicate effort by having to change or even recreate the instance document.

In some cases, the individual skills and authority needed to approve the mapping may go beyond the external reporting function in the organization. The review process may also include staff and decision makers from legal, environmental, mergers and acquisitions, and other functions, who are not likely to have the same level of understanding about XBRL as those in the external reporting function. Therefore, preparers should create a mapping document that will be easy for the necessary individuals to review. The software that preparers choose may assist with this by creating a user-friendly, accessible report. However, preparers may need to create a spreadsheet that contains the appropriate information in a manner that is straightforward for those who are not familiar with XBRL.

8.1.2 Accuracy and Completeness of Tagging

Once preparers have completed the mapping, they also must confirm that the mapping is accurately and completely implemented in the company's extension and instance document.

Rule: Confirm that the elements selected in the mapping are accurately and completely applied in the instance document.



Rule: Confirm that the data (numeric and textual) entered in the instance document matches the data in the published financial statements.



To do so, preparers must compare elements from the published financial statements documented in the mapping with the elements used in the instance document.

Creating a human-readable format of the instance document, called [rendering](#), is usually necessary during the final review process, especially when those accustomed to using hard-copy documents will be involved. However, reading the rendered instance will not identify all errors that may exist in the extension taxonomy or instance document. In practice, technical support is usually required to generate detailed reports on the extension taxonomy, or several different renderings of the instance document (for example, showing element attributes in addition to their labels, or showing the instance using calculation relationships rather than only presentation relationships).

The exact process for ensuring this type of accuracy will depend on the software preparers use and the organization's level of technical support.

8.1.3 Accuracy of Context Assignments

Instance documents typically contain a very large number of contexts. Software can assist in creating and sorting contexts, but contexts, or several contexts, can still be applied to the wrong data.

Checking the accuracy of the context assigned to each piece of data can be done effectively using a printout that segregates each piece of data (numeric and textual) into the contexts to which they have been assigned in the instance document. Context information can be incorporated into a mapping document to facilitate the review.

8.1.4 Accuracy and Appropriateness of Relationships in the Extension

Relationship files in an extension make the extension taxonomy match the presentation, calculation, and dimensional relationships as they exist in the published financial statements. The rules and rules of thumb in this guide indicate what other relationships must or should be present for any preparer-added elements in the extension taxonomy, so the reviewer should check the relationship files for completeness with respect to this guide. Reviewing relationships is the most difficult kind of review to perform because it requires professional judgment as well as an understanding of the meaning of XBRL relationships, element types, and the rules and rules of thumb for preparers. The individuals in the organization who are the most knowledgeable about XBRL should be involved in this review.

8.2 Validation

Rule: Validate the extension taxonomy and instance document.



If preparers leave validation to the end of the extension taxonomy and instance document creation process, they are likely to be overwhelmed with errors. These errors might also be more difficult and time consuming to identify after preparers have a completed document. Therefore, preparers should perform validation checks early and often, so that the errors can be resolved as they occur.

8.3 Review and Approval

The accuracy and reliability that company stakeholders expect from financial statements do not vary based on the format in which those statements are released. XBRL extension taxonomies and instance documents must be subject to the same rigorous review and approval as the financial statements that are filed with the SEC. Preparers should prepare a quality control process specific to their company's process for financial statement preparation, review, and approval. The quality control process must include the external financial reporting function and CFO or equivalent executive.

APPENDIX A: GLOSSARY

abstract – An attribute of an [element](#) to indicate that the element is only used in a hierarchy to group related elements together. An abstract element cannot be used to tag data in an instance document. In the XBRL US GAAP Taxonomy, every element that has calculation children also has a corresponding abstract element.

ASCII character – Technical term preparers may see in warning messages; the characters are only English letters, digits, and common punctuation marks. ASCII stands for American Standard Code for Information Interchange, and omits commonly used formatting characters forward- and backward-tilted apostrophes and double quotes, non-breaking spaces, and bullets.

attribute – A property of an [element](#) including its [name](#), [balance](#), [data type](#), and whether the element is [abstract](#). Attributes of XBRL US GAAP Taxonomy elements cannot be changed.

authoritative reference – Citations to specific authoritative accounting literature (pronouncements, standards, rules, and regulations) derived from various authoritative sources (SEC, FASB, and AICPA) and used to help define an [element](#).

axis (*pl. axes*) – An instance document contains facts; an axis differentiates facts and each axis represents a way that the facts may be classified. For example, Revenue for a period might be reported along a business unit axis, a country axis, a product axis, and so forth.

axis-default relationship – The dimensional relationship indicating that the table axis has a default domain member. In the XBRL US GAAP Taxonomies 1.0, the default is always the domain element.

axis-domain relationship – The dimensional relationship indicating that the table axis has members drawn from a domain.

balance – An [attribute](#) of a monetary item type designated as debit, credit, or neither; a designation, if any, should be the natural or most expected balance of the [element](#)—“credit” or “debit”—and thus indicates how calculation relationships involving the element may be assigned a [weight](#) attribute (-1 or +1).

calculation relationships – Additive relationships between numeric items expressed as [parent-child hierarchies](#). Each calculation child has a [weight](#) attribute (+1 or -1) based upon its natural balance of the parent and child items.

calculation relationships file – A file containing only calculation relationships. An extension taxonomy will typically have at least one calculation relationships file.

camel case – The phrase “Net Change in Assets” becomes “NetChangeInAssets” in camel case. When software requires preparers to provide a name containing no spaces, and changing an English phrase into the symbol makes it hard to read, use camel case. Contrasted with either lower case or upper case, camel case uses capitalization of each word in the phrase to create visual “humps”. Punctuation is always removed. Even an acronym occurring in a phrase also should be converted to camel case (for example, “US GAAP Report” becomes “UsGaapReport”).

concept – XBRL technical term for [element](#).

context – Entity and report-specific information (reporting period, segment information, and so forth) required by [XBRL](#) that allows [tagged](#) data to be understood in relation to other information.

decimal – Instance document [fact](#) attribute used to express the number of decimal places to which numbers have been rounded.

definition relationships file – Technical term for dimensional relationships file.

dimension – XBRL technical term for axis.

dimensional relationships file – XBRL relationships file used to define dimensional relationships between elements. The XBRL technical name for this file is a definition relationships file.

domain – An element that represents an entire set of other elements; the domain and its members are used to classify facts along the axis of a table. For example, “Arkansas” is a domain member in

the domain “States”, and would be used to classify elements such as revenues and assets in Arkansas as distinct from other states. When a fact does not have any domain member specified, that means it applies to the entire domain.

domain member – An element representing one of the possibilities within a domain.

domain-member relationship – Dimensional relationship indicating that a domain contains the member.

element – XBRL components ([items](#), [domain members](#), [dimensions](#), and so forth). The representation of a financial reporting concept, including: line items in the face of the financial statements, important narrative disclosures, and rows and columns in [tables](#).

element definition – A human-readable description of a reporting [concept](#). From an XBRL technical point of view, the element definition is the label with the type “documentation”, and there are label relationships in a label relationships file, but from a user point of view the definition is an unchangeable attribute of the element.

element names file – Part of the [taxonomy](#) that defines XBRL [elements](#) and their [attributes](#) as well as [relationship groups](#).

entry point – XBRL file that brings together a set of [relationships files](#). The file name ends with “.xsd” just like an [element names file](#).

extended link – XBRL technical term for a [relationship group](#).

extension taxonomy or extension – A [taxonomy](#) that allows users to add to a published taxonomy in order to define new [elements](#) or change element relationships and attributes ([presentation](#), [calculation](#), [labels](#), and so forth) without altering the original.

face of the financial statements – Financial statements without the notes or schedules.

fact – The occurrence in an instance document of a value or other information [tagged](#) by a [taxonomy element](#).

FRTA – Financial Reporting Taxonomies Architecture; guides the creation and use of taxonomies by presenting a recommended design architecture as well as rules and conventions for taxonomies and instance documents.

GAAP – Generally Accepted Accounting Principles as defined in AICPA, *Professional Standards*, vol. 1, AU sec. 411 and PCAOB *Standards and Related Rules*, AU sec 411, and *Evaluating Consistency of Financial Statements*, AS 6.

group or relationship group – Highest level of a [parent-child hierarchy](#) used to categorize item relationships at the financial statement, schedule, or industry level.

hierarchy – Trees ([presentation](#), [calculation](#), and so forth) used to express and navigate relationships.

hypercube – XBRL technical term for a table.

imputed value – A value that is not specifically provided but could be calculated based on other provided numbers and calculation weights.

instance or instance document – [XML](#) file that contains business reporting information and represents a collection of financial [facts](#) and report-specific information using [tags](#) from one or more XBRL [taxonomies](#).

integer – A data type indicating that the element is stated in whole numbers.

item – XBRL technical term for a kind of [element](#).

label – Human-readable name for an [element](#); each element has a standard label that corresponds to the element [name](#), and is unique across the taxonomy.

label relationships file – Part of a [taxonomy](#) used to associate labels to [elements](#).

label type – A distinguishing name for each distinct element indicating the circumstances in which it should be used; each is given a separate defining “role” to use in different presentation situations.

line item – Elements that conventionally appear on the vertical axis (rows) of a [table](#).

linkbase – XBRL technical term for a relationships file.

mapping – Process of determining the [elements](#) that correspond to lines and columns in a financial statement and which elements must be created by [extension](#).

name – Unique identifier of an [element](#) in a [taxonomy](#).

namespace – Every element has a Universal Resource Identifier (URI) that identifies the organization that maintains the element definitions, with an indication of what the term covers. In the XBRL US GAAP Taxonomy, namespaces start with “http://xbrl.us/us-gaap/”. A namespace [prefix](#) is not the namespace.

negating label – A [label type](#) that causes numeric values of an element to be displayed with their sign flipped.

nillable – An attribute that appears on all taxonomy elements, and is used (false) on elements that, if used in an instance document, must have a non-empty value. XBRL taxonomy tools normally have the default value for nillable as “true”. There is no need for any extension to define an element with nillable “false”.

non-GAAP – As used in this guide and the XBRL US GAAP Taxonomies v1.0, this term applies to the taxonomies of non-financial information; it does not mean “non-GAAP” in the sense of Regulation S-K Item 10(e).

parent-child hierarchy – Relationship between [elements](#) that indicates subordination of one to the other as represented in a print listing or financial statement presentation. [Relationships files](#) use parent-child hierarchies to model several different relationships, including presentation, summation of a set of facts, and membership of concepts within a domain used as the axis of a table.

period type – An attribute of an [element](#) that reflects whether it is reported as an instant or duration time period.

prefix or namespace prefix – A shorthand sequence of letters for a namespace; “us-gaap”, for example, is a common prefix for the namespace http://xbrl.us/us-gaap/2008-01-31.

presentation relationships – Relationships that arrange elements allowing them to navigate the taxonomy content in parent-child tree structures (hierarchies).

presentation relationships file – Defines the organizational relationships (order) of [elements](#) using [parent-child hierarchies](#); it presents the [taxonomy](#) elements to users and allows them to navigate the content.

reference relationships file – Part of a [taxonomy](#) used to associate references to authoritative literature with [elements](#).

relationship group – A set of relationships that are given a name and description and treated as a whole set.

relationship group description – A human-readable name for a relationship group, specifically used for sorting. For example, “148600 – Statement – Statement of Income” is the name of a relationship group that begins with a number so that it can be sorted easily.

relationship group role or relationship group name – A unique identifier, resembling a [namespace](#), that is shared by related calculation, presentation, and dimension relationships all used together. For example, http://xbrl.us/us-gaap/role/statement/StatementOfIncome is a relationship group role.

relationships file – Part of a taxonomy used to define specific relationships and other data about [elements](#). There are five standard relationships file types: [Presentation](#), [Calculation](#), [Definition \(Dimensions\)](#), [Label](#), and [Reference](#).

render or rendering – To process an instance document into a layout that facilitates readability and understanding of its contents.

root – The top level of a [tree](#); can appear only once in that tree.

scaling – A process that automatically scales numeric data by value, thus saving time of entering zeros during the entry or creation process. XBRL does not support the scaling of numeric values (all values must be reported in their entirety); however, it is a feature commonly found in instance document creation software.

scenario – Tag that allows for additional information to be associated with facts in an instance document; this information encompasses in particular the reporting circumstances of the fact, as for example “actual” or “forecast”. The scenario of any fact can be left unspecified.

schema – Technical term for an element declaration file.

segment – [Tag](#) that allows additional information to be included in the [context](#) of an [instance document](#); this information captures segment information such as an entity’s business units, type of debt, type of other income, and so forth.

sign value – Denotes whether a numeric fact in an instance has a positive (+) or negative (-) value.

standard label – The default [label](#) for an element. An extension may override the standard label.

suppress (a relationship) – An extension effectively can remove a parent-child relationship in a presentation, calculation, or dimension relationship. It is not actually deleted from the XBRL US GAAP Taxonomy, just made ineffectual. The technical term is “prohibiting the arc”.

table – An element that organizes a set of axes and a set of line items so as to indicate that each fact of one of the line items could be further characterized along one or more of its axes. For example, if a line item is “Sales” and an axis is “Scenario” this means that an instance document could have facts that are either for an “unspecified scenario” or for a specific scenario such as “actual” or “forecast”.

table-axis relationship – Dimensional relationship indicating that a table uses a particular axis. The XBRL technical name for this is the “hypercube-dimension” relationship; software tools may provide other names.

tag (noun) – Markup information that describes a unit of data in an [instance document](#) and encloses it in angle brackets (“<>” and “</>”). All facts in an instance document are enclosed by [tags](#) that identify the element of the fact.

tag (verb) – To apply markup to an instance document.

target namespace – The [namespace](#) for which an element names file defines elements. The uniqueness of the target namespace prevents element name collisions between the various element names files, assisting taxonomy users to recognize the restrictions between the original element names files and extension element names files.

taxonomy, taxonomies – Electronic dictionary of business reporting [elements](#) used to report business data. A [taxonomy](#) is composed of an [element names file](#) (.xsd) and [relationships files](#) directly referenced by that schema. The taxonomy schema files plus the relationships files define the concepts (elements) and relationships that form the basis of the taxonomy. The set of related schemas and relationships files altogether constitute a taxonomy.

tree – Common name for a display of a [hierarchy](#), with “[roots](#)”, “branches” and “leaves”.

tuple – Tuples are not used in the XBRL US GAAP Taxonomies v1.0, and best practice is not to use them in any extension. Tuples may be mentioned in software applications to ensure backward compatibility with previously created instance documents. The functionality previously addressed with tuples has been replaced with tables.

type or data type – Data types (monetary, string, share, decimal, and so forth) define the kind of data to be tagged with the element name.

unit of measure – The units in which numeric items have been measured, such as dollars, shares, Euros, or dollars per share.

validation – Process of checking that [instance documents](#) and [taxonomies](#) correctly meet the rules of the [XBRL specification](#).

weight – Calculation relationship [attribute](#) (-1 or +1) that works in conjunction with the [balance](#) of the [parent and child](#) numeric [elements](#) to determine the arithmetic summation relationship between

them. A parent with a balance credit that has two children, one with a balance type debit and the other with a balance type credit, would, in an XBRL calculation relationships file, have the parent with a weight of +1, the debit child with a weight of -1, and the credit child with a weight of +1. As can be seen, the parent's balance drives the weight of the children addends.

XBRL – Stands for Extensible Business Reporting Language; an [XML](#)-based standard for electronic communication of financial and business data.

XBRL footnote – An instance document element that provides additional information for specified values by creating linkages between them and a footnote element containing this additional information.

XBRL specification – Detailed description of [XML](#) syntax, semantics, and structures, and so forth that prescribe how XBRL is constructed. The current Specification 2.1 is used primarily by IT professionals in developing tools and software for XBRL applications.

XBRL table – A [table](#).

XBRL US GAAP Taxonomies v1.0 – A set of [taxonomies](#) for building financial reporting [instance documents](#) for companies that report using US GAAP.

XML – Stands for Extensible Markup Language, which is used to describe and define data by allowing users to define their own [tags](#) (in contrast to HTML where the tags are predefined). [XBRL](#) is an XML-based standard.

APPENDIX B: SIC CODE MAPPING TO INDUSTRY ENTRY POINT

Although the entry point on which a company extension is based is entirely up to the preparer, the table below may be helpful in checking to see whether a company that is well characterized by an existing SIC code already has a suggested entry point. The table shows SIC codes having twenty or more SEC registrants.

Figure 125 SIC Codes with Suggested Industry Entry Points

Division	Major Groups	Description	Entry Point
A	01-09	Agriculture, forestry, and fishing	CI
B	10-14	Mining	CI
C	15-17	Construction industries	CI
D	20-36	Manufacturing	CI
E	40	Transportation, communication, and utilities	CI
F	50-51	Wholesale trade	CI
G	52-59	Retail trade	CI
H	6	Financial, insurance, and real estate industries	
	60	Depository institutions	BASI
	61	Nondepository credit institutions	BASI
	62	Security and commodity brokers, dealers, exchanges, and services	BD
	63	Insurance carriers	INS
	64	Insurance agents, brokers, and services	INS
	65	Real estate	RE
	67	Holding and other investment offices, except trusts	IM
I	70-89	Service industries	CI

APPENDIX C: EXTENSION NAMING AND FILES

The first step in creating an extension is to decide on its name and define a convention for naming its files. XBRL-enabled software products do this in different ways. This appendix provides details that may or may not be handled by a specific product.

[Namespaces](#) are a way of identifying where different parts of an XML document come from. Because XBRL is built on top of many XML-based technologies, several namespaces must be declared. Preparers must define a unique namespace for the concepts defined in the extension, and a “prefix” which is a shorthand way of referring to the namespace. Figure 126 shows example namespaces.

Figure 126 Namespace Examples

Prefix	Namespace	Origin and Meaning
usfr-pte	http://www.xbrl.org/us/fr/gaap/pte/2005-02-28	The US (us) chapter of XBRL International Inc. (www.xbrl.org) published a Financial Reporting (fr) taxonomy as of February 28 th 2005 that covered GAAP (gaap) based financial statements including a set of Primary Term Elements (pte).
us-gaap	http://xbrl.us/us-gaap/2007-12-31	XBRL US Inc. (xbrl.us) published a US GAAP (us-gaap) taxonomy as of December 31 st 2007.
abc	http://xbrl.abccorp.com/2012	ABC has an extension for their XBRL filings that was created during 2012. This does not mean it is only relevant to the year 2012.

A namespace looks like a worldwide web address, but it is not. The leftmost part of a namespace is meant to give a human reader a clue as to who owns the namespace, but that is the only relationship to a web address. The third example above is simple and appropriate for a company namespace. Preparers should strive to build an extension that will work properly for multiple reports for at least a year of filings, if not more; indicate in the namespace the year it was created.

Rule of Thumb: Define a namespace in the form “

[Section 3, Understanding and Using Taxonomies](#), explains the taxonomies’ entry points and provides the criteria for selecting an entry point appropriate to a company’s industry and reporting needs. An extension is always built upon some existing entry point; the technical term is that the extension “imports” the entry point from where it is published on the XBRL US website. Some software products give preparers a menu of choices of XBRL US GAAP Taxonomy entry points from which to extend.

Rule: Import at least one of the entry points from the XBRL US, Inc. website to create an extension; the location of an XBRL US GAAP Taxonomy entry point is a web address that starts with <http://xbrl.us/us-gaap/1.0> and ends with “[{CCYY-MM-DD}.xsd](#)”. 

When the preparer creates an extension taxonomy, the software saves it in the form of files including element declaration files (technically, “XML Schemas”) and relationships files (technically, “linkbases”). To submit the filing to the SEC, file names must not exceed 32 characters, element declaration files end with “.xsd” and relationship files end with “.xml”.

Rule: Check the SEC’s website for the latest version of the EDGAR Filing manual and comply with the latest version. The rules about EDGAR filings in this guide are from the EDGAR Filing Manual Volume II, Version 5, August 2007, §5.2.4.1, which may not reflect the latest rules. 

There are further limitations on file names. Element declaration files must match

{Ticker Symbol}{more letters}-CCYMMDD.xsd

and relationship files must match

{Ticker Symbol}{more letters}- CCYMMDD_{relationship file abbreviation}.xml

Figure 127 Relationship File Abbreviations

Relationships File	Abbreviation
Calculation	cal
Dimension (technically, "definition")	def
Label	lab
Presentation	pre
Reference	ref

The format CCYMMDD is an international standard for dates also used in the United States; sorting files by name has the same effect as sorting them by date.

Rule: Use the end of the reporting period as the CCYMMDD date in a file name, not the date of the submission. 

The following example applies the file naming rules for ABC Company's 2013 fiscal year end of 31 December:

abccorp-20131231_cal.xml ([calculation relationships file](#))

abccorp-20131231_lab.xml ([label relationships file](#))

abccorp-20131231_pre.xml ([presentation relationships file](#))

abccorp-20131231_ref.xml ([reference relationships file](#))

abccorp-20131231.xsd ([element names file](#))

Rule: Include all of the element name and relationships files of the extension in the same folder. 

Technically advanced preparers with appropriate software tools can create an extension from selected, specific entry points, leaving out any relationship groups not used. For example, the broker-dealer entry point typically used by the average preparer contains *all* statements (even a cash flow statement with direct operating cash flows) and *all* disclosures (even a disclosure concerning oil and gas reserves). Figure 11, "Four Entry Points per Industry", showed some additional entry points, and there is another level of entry points (one per statement, and one per disclosure) from which a totally customized extension could be built.

Another approach that technically advanced preparers may use is to remove *all* XBRL US GAAP Taxonomy presentation, calculation, and dimensional relationships, but only when the extension taxonomy is finalized. Maintaining an "internal" working taxonomy for preparation and an "external" finalized taxonomy with all the relationships necessary for validation remaining identical in the two versions is best done only by technically advanced preparers.

APPENDIX D: TERMINOLOGY IN THE XBRL US GAAP TAXONOMY

Figure 128 Spelling Used in Preference to Alternative Spellings

Spelling Used	Not Used	Not Used	Not Used	Not Used	Not Used
Accrued Liabilities	Accrued Expenses	Accrued Expense	Accrued Liability		
All	all				
Assets Held-for-sale , at Fair Value , at Market Value	Assets-Held-for-Sale , Estimated Fair Value , at Market	Assets Held-for-Sale	Assets Held for Sale		
Available-for-Sale , Carrying Amount	Available for Sale , Carrying Value	Available-For-Sale , at Carrying Amount			
Deferred	Deferred/Unearned	Unearned			
Due from	Amounts Due from	Amounts Due From			
Due to	Amounts Due to	Amounts Due To			
Due to (from)	Due to or from	Due from or to	Amounts Due from (to)	Amounts Due to (from)	
Entity	Company	Corporation	Enterprise	Organization	Preparer
Held-for-disposal	Held for Disposal	Held-for-Disposal			
Held-for-investment	Held for Investment	Held-for-Investment			
Held-for-lease	Held for Lease	Held-for-Lease			
Held-for-resale	Held for Resale	Held-for-Resale			
Held-for-sale	Held-for-Sale	Held for Sale			
Held-for-use	Held for Use	Held-for-Use			
Held-in-portfolio	Held in Portfolio	Held-in-Portfolio			
Held-to-maturity	Held to Maturity	Held-to-Maturity			
in (out)	in or out	In or Out			
Increase (Decrease)	Increases (Decreases)				
Indefinite-Lived	Indefinite lived	Indefinite Lived			
In Process	In-Process		In-process		
Interest-bearing	Interest Bearing	Interest-Bearing			
Less	less				
Long-term	Long-Term	Long term	Long Term		
Long-term Debt, Current	Long-term Debt, Current Portion	Current Portion of Long-term Debt			
Medium-term	Medium-Term	Medium term	Medium Term		
Net of Tax	Net of Tax Effect	Net of Income Tax			
Nonaccrual	Non accrual	Non-accrual	Non-Accrual		
Noncancelable	Non cancelable	Non-cancelable	Non-Cancelable		
Noncash	Non cash	Non-cash	Non-Cash		
Noncurrent	Non Current	Non-Current	Non-Current		
Nondeductable	Non deductible	Non-deductable	Non-Deductable		
Noninterest	Non interest	Non-interest	Non-Interest		
Noninterest-bearing	Noninterest Bearing	Noninterest-Bearing			
Nonoperating	Non operating	Non-operating	Non-Operating		
Nonperforming	Non performing	Non-performing	Non-Performing		
Nonproduction	Non production	Non-production	Non-Production		
Nonrecurring	Non recurring	Non-recurring	Non-Recurring		
Nontaxable	Non taxable	Non-taxable	Non-Taxable		
Not	not				
Other	Miscellaneous				
Per	per				
Phase-in	Phase-In	Phase In	Phase in		
Phase-out	Phase-Out	Phase Out	Phase out		
Postemployment	Post-Employment				
Postretirement	Post-Retirement				
Process	process				
Pro Forma	Pro forma	Proforma	Pro-forma	Pro-Forma	ProForma
Provided by (Used in)	Provided By (Used in)	Provided by (Used In)	Provided By (Used In)		
Share-based	Share-Based	Sharebased	Share based		
Short-term	Short Term	Short-Term	Shortterm		
US	U.S.				
Where	where				
Write down	Write Down				
Write-down	Write-Down				
Write off	Write Off				
Write-off	Write-Off				
Write-offs	Write-Offs	Writeoffs			

APPENDIX E: VALIDATION

Taxonomy [validation](#) is a process whereby a software program analyzes a taxonomy to confirm that the taxonomy complies with the requirements of XBRL specifications. Validation software may be a standalone product, but it is more likely to be incorporated into taxonomy editing software. A validator provides error and warning messages to identify and help resolve issues. There are three levels of validation.

1. Validation against XBRL specifications, which is an absolute requirement; the extension *must* be valid according to the rules of XBRL specifications. Although some software automates validation during the creation process, alerts preparers to potential issues, and even prevents preparers from saving files that are not valid, preparers should validate and save their work often. Do not use software or services that do not fully support the most updated XBRL specifications. The XBRL US GAAP Taxonomy uses the latest XBRL specifications as of the date of taxonomy publication, so vendors may need to update and upgrade their software. Check with the software vendor to determine whether their software supports the most current XBRL specifications. Errors must be corrected before proceeding with the creation of an extension. Warnings allow work to continue, but subsequently lead to undesirable results
2. Software vendor-specific validation; some products enforce additional rules above and beyond XBRL itself. Unfortunately, software with vendor-specific validation will produce spurious error messages; worse, it may not even open files created with software that does not enforce the same vendor-specific rules.

Rule of Thumb: Avoid or disable vendor-specific validation rules or restrictions that limit the XBRL files that the product can use.



3. [FRTA](#) validation, which may be built into some software, provides a number of important consistency and quality checks, such as identifying elements that have the same standard label, or that have no definition attribute. Compliance with *all* FRTA rules, however, is neither required nor recommended. There are technical details of the FRTA rules that can be disregarded when preparing an extension taxonomy.

Rule: Ignore FRTA 1.0 validation error messages referring to rules 2.1.10, 2.1.12, 3.1.2, 3.1.7, and 4.3.2.



FRTA 1.0 is a set of over 120 rules published in 2005 before XBRL had tables and before taxonomies of over 10,000 elements were contemplated. The XBRL US GAAP Taxonomies v1.0 violate the letter of the rules without violating their spirit. For each of the waivers listed in Figure 129, the rule is a candidate for XBRL International to reconsider and change its wording to closely correspond to its original intent. Error messages referring to FRTA rules 2.1.10, 2.1.12, 3.1.2, 3.1.7, and 4.3.2 should be ignored. FRTA 1.0 validation of the taxonomies yields over 20,000 occurrences of these error messages.

Figure 129 FRTA 1.0 Rule Waivers

Rule	Definition
2.1.10	An element must have a standard label in the DTS of the schema where it is defined.
2.1.12	An element must have a documentation or reference in the DTS of the schema where it is defined.
3.1.2	An arc must have only its standard or LRR approved arc role.
3.1.7	All arcs within an extended-type link must have the same arc role.
4.3.2	Each unique taxonomy schema target namespace must have a namespace prefix of one to twelve non-escaped characters, which will be its recommended namespace prefix.

Rules 2.1.10 and 2.1.12: These are mandatory rules that mean “if preparers load the [element names file](#) of an element then preparers must load the standard label and either a reference or definition”. FRTA 1.0 did not anticipate 10,000+ element taxonomies. The element names file of the XBRL US GAAP Taxonomy is three megabytes, while the documentation and references total over twenty-three megabytes. The size of the documentation and reference files is not forced on a user if all they want to do is validation and processing without display.

Rule 2.1.12: Some abstract elements and elements in the Non-GAAP taxonomies have neither documentation nor references. Abstract elements exist only for structural reasons and do not appear in instance documents. Non-GAAP taxonomies are arguably not financial, although they otherwise comply with FRTA 1.0.

Rules 3.1.2 and 3.1.7: This is not considered a violation because it relates to XBRL Dimensions.

Rule 4.3.2: The namespace prefixes for seventeen of the entry point files that contain no element or type declarations exceeds the limit of twelve characters. The limit of twelve characters is not relevant in that situation.

APPENDIX F: WEBSITES FOR XBRL PREPARERS

www.sec.gov/xbrl

The US Securities and Exchange Commission's (SEC) website section on "Interactive Data and XBRL Initiatives" includes a list of voluntary filers, EDGAR information, press releases, and roundtable transcriptions. The website also offers a link to all EDGAR-compatible taxonomies at www.sec.gov/info/edgar/edgartaxonomies.shtml. Other valuable information appears as follows:

- XBRL Voluntary Financial Reporting Program on the EDGAR System—Final Rule: www.sec.gov/rules/final/33-8529.htm#IIB
- XBRL voluntary filings: www.sec.gov/Archives/edgar/xbrl.html
- Interactive Financial Report Viewer: www.sec.gov/spotlight/xbrl/xbrlwebapp.shtml

www.xbrl.org

XBRL International Inc. is a not-for-profit consortium of approximately 550 companies and agencies worldwide that works to build and promote the adoption of XBRL. The site provides information about the nature, uses, and benefits of XBRL, as well as technical and training information, news, and details about conferences and other XBRL-related events worldwide.

www.xbrl.us

XBRL US, Inc. is a nonprofit member organization and local jurisdiction of XBRL International. The site is the location of the XBRL US GAAP Taxonomies v1.0 created through the organized efforts of XBRL US, Inc., with resources and input from the XBRL information supply chain, which includes XBRL US Inc., public accounting firms, securities analysts, US financial data aggregators, software vendors, and the SEC. The site includes tutorials such as "XBRL 101" and "Using Taxonomies". It also features news feeds related to data submitted by voluntary filers and to jobs in the XBRL field. The website provides detailed information about XBRL products and services offered by XBRL US, Inc. member organizations at www.xbrl.us/vendors/Pages/default.aspx

www.iasb.org/XBRL

- Website of the International Accounting Standards Committee Foundation focuses on developing and promoting global accounting standards. The site provides news and information about international XBRL efforts, an "EduCentre", and online tools related to international XBRL taxonomy. Particularly useful parts of the site includes www.iasb.org/xbrl www.iasb.org/xbrl/index.htm

www.xbrleducation.com

The website of the XBRL Education Center at Bryant University provides a series of resources for learning about XBRL and its impact on the financial community, including links to informative articles, an archive of XBRL International conferences, and opportunities to subscribe to XBRL blogs and other news sources.